



DRIPWORKS

 **Quality Drip Irrigation**



Drip Planning Guide



DRIPWORKS

 *Quality Drip Irrigation*

Drip irrigation is used on farms both large and small, in vineyards, home gardens, nurseries, urban balconies and rooftops all over the world. When DripWorks began selling drip irrigation products back in 1992, people were spraying their valuable water into the wind, or flood irrigating with uneven results. DripWorks has been an innovative leader as demand for and popularity of drip irrigation has boomed.

What are the benefits of Drip Irrigation?

Water: Drip irrigation is the most efficient method of watering today.

- Places a precise amount of water where you need it
- Prevents overwatering
- Results in less weeding
- Conserves water
- Saves money



Drip Irrigation Uses
30-50% Less Water

Time: Installing a drip system will not only save you water, but time.

- Eliminates hours of hand watering
- Can be fully automated with a timer
- Reduces weeding time



Drip Irrigation Saves
You Time

Versatility: Drip irrigation systems can be used just about anywhere.

- Gardens, vineyards, greenhouses, row crops
- Existing landscapes
- Hillsides or flat terrain
- Long lasting and adaptable



Drip Irrigation is
Versatile



Ancient Drip Irrigation

The origins of irrigation can be traced back to the ancient Egyptians, who in the 6th millennium BCE developed the technique known as “flood irrigation” by creating a network of canals to channel water from the Nile to their gardens. There is also evidence of irrigation systems arising in China during the same period and subsequently in the Andes of Peru during the 4th millennium BCE and parts of ancient India in the 3rd millennium BCE.

Reference to the use of buried porous clay pots that wept water into the surrounding soil goes back thousands of years in Egypt and China, and is considered the first form of drip or trickle irrigation (aka micro-irrigation).

Modern Drip Irrigation

The roots of modern day drip irrigation (pardon the pun) can be traced to 1860, when systems of clay pipes were developed in Germany for combination drainage/irrigation systems, used soon after in Afghanistan in 1866. In the 1920’s this idea was expanded upon (again in Germany) utilizing a system of perforated clay pipes. The use of plastics after WWII led to the invention of plastic pipes with long flow paths by Australian Hannis Thill and a decade later to the development of the first plastic emitter by Simcha Blass of Israel.

Though many point to one person or another as the “Father of Drip Irrigation,” it is clear that the road to present day drip irrigation method was built by more than one individual. As Dr. Daniel Hillel, recipient of the 2012 World Food Prize for his role in conceiving and implementing improved methods of food production with “micro-irrigation,” said: “No one person invented drip irrigation.”

Present Day Drip Irrigation

Today there is a huge variety of drip irrigation methods from which to choose: individual emitters and drip-pers, misters, micro-sprayers, mini-sprinklers, emitter tubings, and drip tapes. In addition, there is an entire realm of filters, pressure regulators, water timers, fertilizer injectors, tools, and accessories available to help install and maintain a drip irrigation system.

With drought in many parts of the country being a serious issue, drip irrigation has become even more relevant. If you’re looking for a way to take action and reduce your water consumption, there is no quicker way to see results than installing a drip irrigation system. Drip irrigation will save you water, time and money.

Before Getting Started

Like all industries, drip irrigation has terms which can be confusing, especially to the beginner. Here are a few common terms you may find in this guide, our catalog, and on our website.

Glossary of Terms

Flow: 1) The amount of water available for the drip system expressed in gallons per hour (GPH) or gallons per minute (GPM). Flow is a determining factor in how many plants (or how large an area) can be watered at one time.

2) The total amount of water moving through the system as it exits emission devices.

Pressure: Measured in pounds per square inch, or PSI, pressure is the force pushing the flow of water. Your pressure can be determined by using a pressure gauge.

Constant Pressure: In a drip irrigation system, the condition that occurs when the spigot or valve is left open, leaving any downstream devices-timers, filters, regulators, tubing, fittings, and emitters-under constant pressure.

Dynamic Pressure: The fluctuating pressure that occurs within a drip irrigation system when valves are opened and closed and emitters turned on and off.

Water Source: Where the water originates. This can be a municipal system, a well, a pond, spring, or stream.

Point of Connection: Also known as a POC, your point of connection will be a spigot, hydrant, gate valve, or other connection that brings the water into your watering area.

Filter: A device used to remove particles from the water that might otherwise clog your emitters. Many water sources, especially municipal systems, are relatively free of debris. However, we still recommend filtration to ensure consistent, trouble-free operation of your system.

Zoning: The division of a drip irrigation system into areas that require similar watering rates or that would exceed the available flow of the system if watered together.

Mainline: Polyethylene tubing used to carry water from your POC to and throughout your drip system.

Branch Line: Polyethylene tubing that attaches to the mainline to bring water to an individual plant or to a zone. Branch tubing is generally ¼" or ½" tubing.

Pressure Compensating: (PC) Emitters distribute water equally throughout the whole system regardless of row length (within limits) and elevation changes. PC products are available in drippers, sprayers, or sprinklers.

For expanded definitions and other drip irrigation terms, visit our [online glossary](#).

Getting Started

If you're new to drip irrigation and wondering how to get started, we highly recommend one of our complete kits. Most kits are available in Small, Medium, and Large versions (unless otherwise stated) and each kit is designed for a specific purpose. Everything required is included for you to quickly install a drip system .



[Drip Row Crop Tape Kit](#)

These kits use drip tape, an extremely efficient product that works best for long rows on terrain that is relatively flat. All of these low-flow Drip Tape Kits use longer-lasting, 15 mil tape with emitters spaced every 8" and will cover from 200'-4000' . If you have row crops these kits are definitely what you need.

[Header Add-On Kits](#)

These kits are available in 1/2" and 3/4" versions to make dividing your system into separate watering zones quick and easy.



[Garden Bed Kit](#)

As the name implies, this kit is perfect for framed or unframed garden beds. These kits use Soaker Dripline, 1/4" tubing with factory-installed emitters spaced at 12". Soaker Dripline is one of the most versatile drip irrigation products you'll ever use. This product is very flexible, and can be configured to accommodate a wide range of situations. Often used to water short rows in a bed, it can also be circled around a potted plant or spiraled around a small tree or shrub. Being a non-pressure compensating product, it can operate down to 2 PSI, making it ideal for low pressure and gravity fed watering situations.



[Deck Garden Kit](#)

The deck garden kit includes both 1/4" Soaker Dripline with emitters spaced every 12" and 1/2 GPH Pot Drippers. This combination of products can be used to water both large and small planter boxes and containers on a porch or deck. Whether your deck area has just a few flower pots or an entire kitchen garden these kits include everything you need to water 45 to 280 containers of varying sizes.



Rose & Shrub Kit

The Rose & Shrub Kit utilizes PC (Pressure-Compensating) Shrubblers to insure even watering at all points within your drip irrigation system. Mounted on convenient stakes, these emitters are easy to install and virtually maintenance free. At 30 PSI they output 8 GPH via 8 “fingers” of water that are emitted in a 12” diameter pattern. As with all our kits, everything you need to water your roses or shrubs is included.



Individual Plant Kit

Whether you’re looking to water a group of containers or individual landscape plantings, this kit will meet your needs. Using a variety of 1 GPH, 2 GPH, and 4 GPH Take-Apart-Emitters (aka “Flag Emitters”), the Individual Plant Kit will water from 60 to 240 plants, depending on which version you choose. If you have lots of individual plantings scattered about, this is the kit for you.



Greenhouse Misting Kit

Designed to cover two 4’ x 10’ tables, the Greenhouse Misting Kit is ideal for seed propagation, foliage watering, and cooling. Each of the ten misters includes an anti-drip device to prevent dripping after the water is turned off. Like our other kits, this one has everything to get your greenhouse going. Though only one version of this kit is currently available, it is easily expandable from 10 to 40 misters.

DIY (Drip Irrigation Your Way)

Maybe you're the hands on type or you have some experience with drip irrigation but need more guidance than a brief product description and a few specs. If so, this next section is for you.

Step 1: Gather Information

1. Every drip irrigation system has a water source; municipal, well, pond, creek, stream, or irrigation ditch. If your answer is anything other than municipal, emitter clogging particulates may be a factor. Though we recommend a screen filter for any system, if your water source has high levels of algae or other organic matter, a disc filter may be required.
2. What is your point of connection (POC)? In most backyard gardens it will likely be some type of hose thread faucet, tap, or spigot. But if it's a hydrant, ball valve, or gate valve it may be a pipe thread connection. You'll need to know.
3. What area(s) do you want to water? A sketch of the garden should include distances from POC's to your watering areas. (it doesn't have to be fancy). This will help determine the amount of mainline and number of branch lines you need.
4. What is your flow rate. Knowing your flow rate is critical to sizing your system (knowing the pressure at your POC is also extremely helpful) .



Determining Your
[Flow Rate](#)

Seconds to fill a *1 Gallon Container	5	6	7	8	9	10	11	12	13	14
GPH	720	600	514	450	400	360	327	300	277	257

*** If filling a 5 gallon container multiply the GPH x 5**

5. What will you be watering? Different plants have different watering requirements. Knowing what you are watering will be a determining factor in choosing what emitters will best suit your needs.

To determine the flow in gallons per minute (GPM) and per hour (GPH):

Place a 1 or 5-gallon container beneath the water source outlet, open the valve completely, and time the number of seconds it takes to fill the container.

$(60 \text{ seconds per minute} / \text{number of seconds to fill}) \times (\text{number of gallons}) = \text{GPM}$

Or, use our online [Flow Calculator](#).

Soil Types

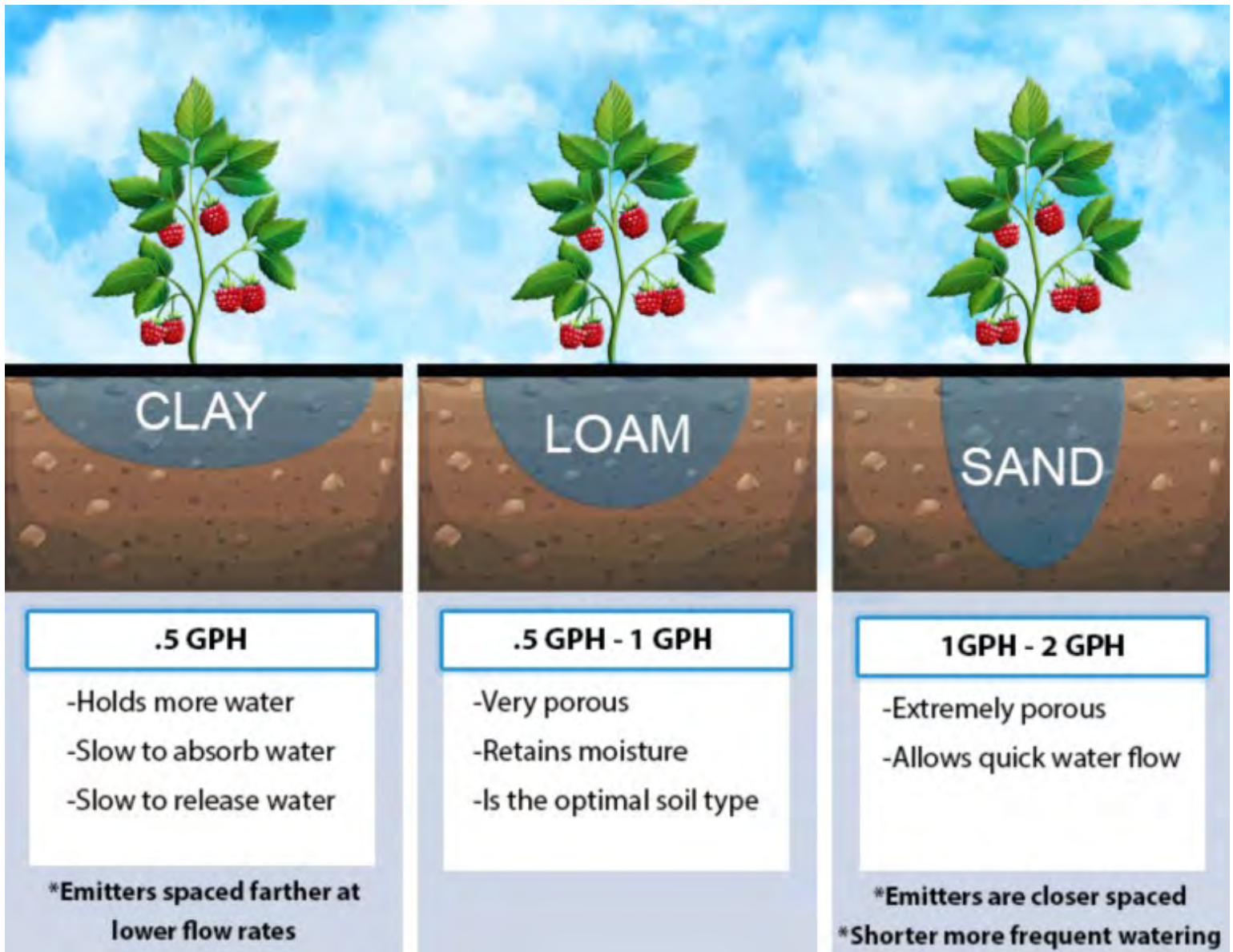

Soil type is another factor that will determine what type of emitters you need. There are three main soil types, Clay, Loam, and Sand, each with a different absorption rate.

Clay absorbs water slowly, causing it to spread on the surface and form a roughly inverted cone shape below ground. For that reason, watering slowly with a 0.5 GPH emitter is best to achieve efficient penetration in clayey soils.

Loam absorbs water at an even rate, usually forming a cone-shaped pattern as it spreads below ground. A 0.5-1 GPH emitter is usually sufficient for loamy soils.

Sand absorbs water quickly in an almost straight down pattern. In most cases a 1-2 GPH emitter will provide the right amount of water to insure root coverage in sandy soils.

Step 2: Select Your Products

Use the following information to determine the type of drip system that is most appropriate for your garden. When selecting products for your system there are a few things to take into consideration, such as soil types and plant watering needs. For questions on a particular plant's needs, consult a local nursery or contact a horticulturist.

Basic Drip Emitters are lower cost and their flow will vary slightly depending on pressure. At low pressures basic emitters will flow more consistently than Pressure Compensating emitters. These emitters are used to water individual plants.



Pressure Compensating (PC) Emitters deliver a precise amount of water. They flow consistently from one emitter to the next regardless of changes in pressure or elevation. These emitters are self-flushing which makes them less likely to clog. Use these emitters to water individual plants.

1/4" Soaker Dripline is a non-pressure compensating product that consists of 1/4" poly tubing with built-in emitters spaced every 6, 9, or 12 inches. Its recommended use is in shorter garden beds and containers. Use for square foot gardening or in densely planted areas. This product is highly effective in lower pressure systems.



1/2" Inline Emitter Tubing consists of 1/2" poly tubing with built-in PC emitters. It is offered in a variety of spacing options and can be used in long rows, on uneven ground, and on hillsides. Use in densely planted areas or circle around root zones to water trees.



Drip Tape is best for long, straight row crops. It is the most economical way to water your plants and is easy to install and maintain.



Sprayers, sprinklers, and misters are used to distribute water over larger areas and work best for ground covers and densely planted beds.



Micro-Jet

Pop Up

C-Frame
Downspray

Bubbler

Shrubber
(Non-PC)

MP Rotator
K-Rain Rotator

Sprayer
Spectrum

Mini-Jet

Ein Dor

Step 3: Design a Drip System

Now that you have made a sketch of your garden and have chosen the products that fit your needs, another key factor in designing your drip system is your available flow. Flow will determine the number of plants or areas which can be watered at any given time.

Example: Let's assume an available flow rate of 240 gallons per hour (GPH). This means you can use up to 240 emitters with a 1 GPH output or 480 emitters that output .5 GPH.

In addition to flow, it is helpful to know your water pressure—the force behind the flow. If your water pressure exceeds what your drip system needs or can handle, a pressure regulator will be required. A pressure regulator reduces incoming water pressure. See page 7 for instructions on how to determine your flow.

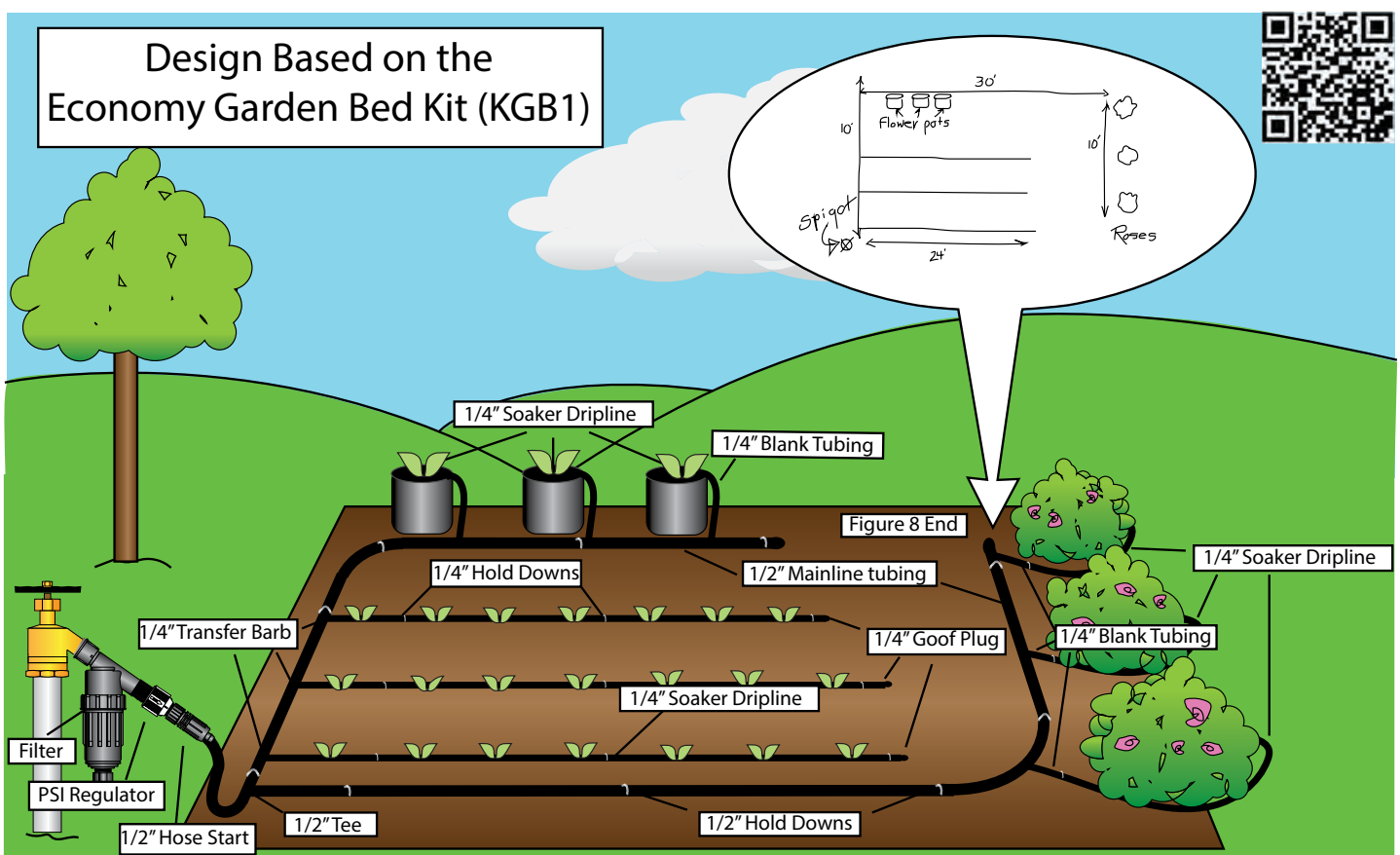

Turning Your Garden Sketch into Reality

After looking over the initial sketch (page 7) and considering the available drip irrigation products (page 5), 1/4" Soaker Dripline seems most suitable for a small garden of this type.

The **Garden Bed Economy Kit (KGB1)** includes a 100' roll of Soaker Dripline with emitters spaced every 12". This versatile product is ideal for the mixture of short rows, containers, and small shrubs we find in this situation and the kit includes everything required to quickly get your garden up and running.

Typical backyard garden hose threaded start

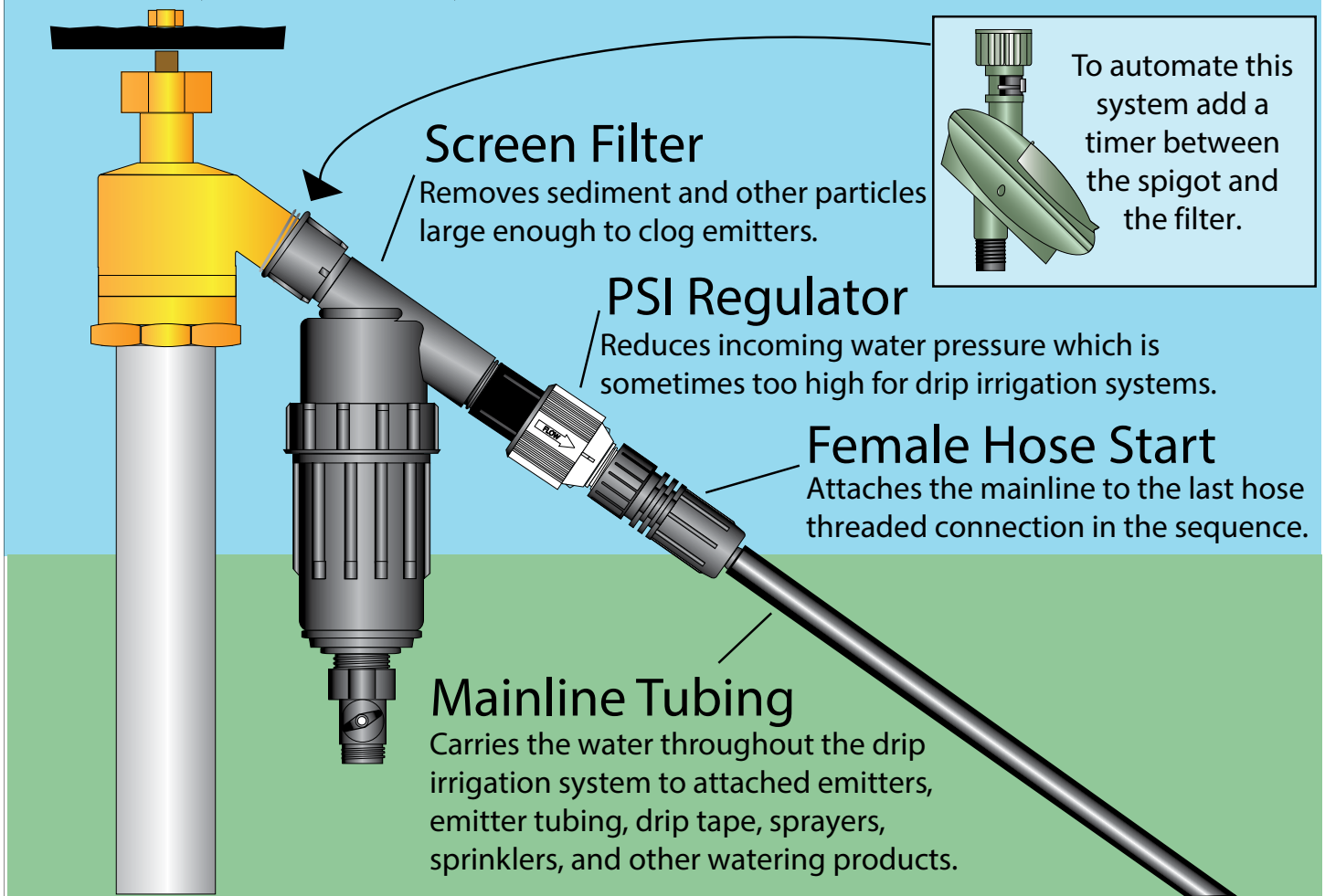

Installation Tips

- Before rolling out the mainline, warm the roll of tubing in the sun or inside the house to make it more pliable
- When installing your drip lines, consider mulching over them. This will increase the tubing's lifespan and help protect it from environmental hazards.
- Once the mainline and supply lines are installed, it is recommended that you flush your lines with clean water for a minute or two (you can collect and reuse it!) before installing emitters or bringing the system up to pressure. This will remove any debris in the lines.
- Add a backflow prevention device. Local codes often require a backflow prevention device to protect your personal and municipal water supply from contamination.

• Automate your system with a [battery](#) (DC) or [electric](#) (AC) timer.



[How to Use
Easy Loc
Fittings](#)

Determining the number of watering zones

The number of zones required is determined by available flow and/or the watering needs of different planting groups that require their own watering zone. For instance, if your 1/2" mainline tubing, which carries about 240 GPH, is feeding emitters with a total flow of 325 GPH, the system should be divided into 2 watering zones.



The Galcon Alternator Valve

The [alternator valve](#) makes it fast and easy to divide your flow into two zones.



[Galcon Alternator Valve](#)

Header Packages

[Headers](#) quickly divide your system into zones by creating submains. Available in 1/2" or 3/4" - Tubing not included

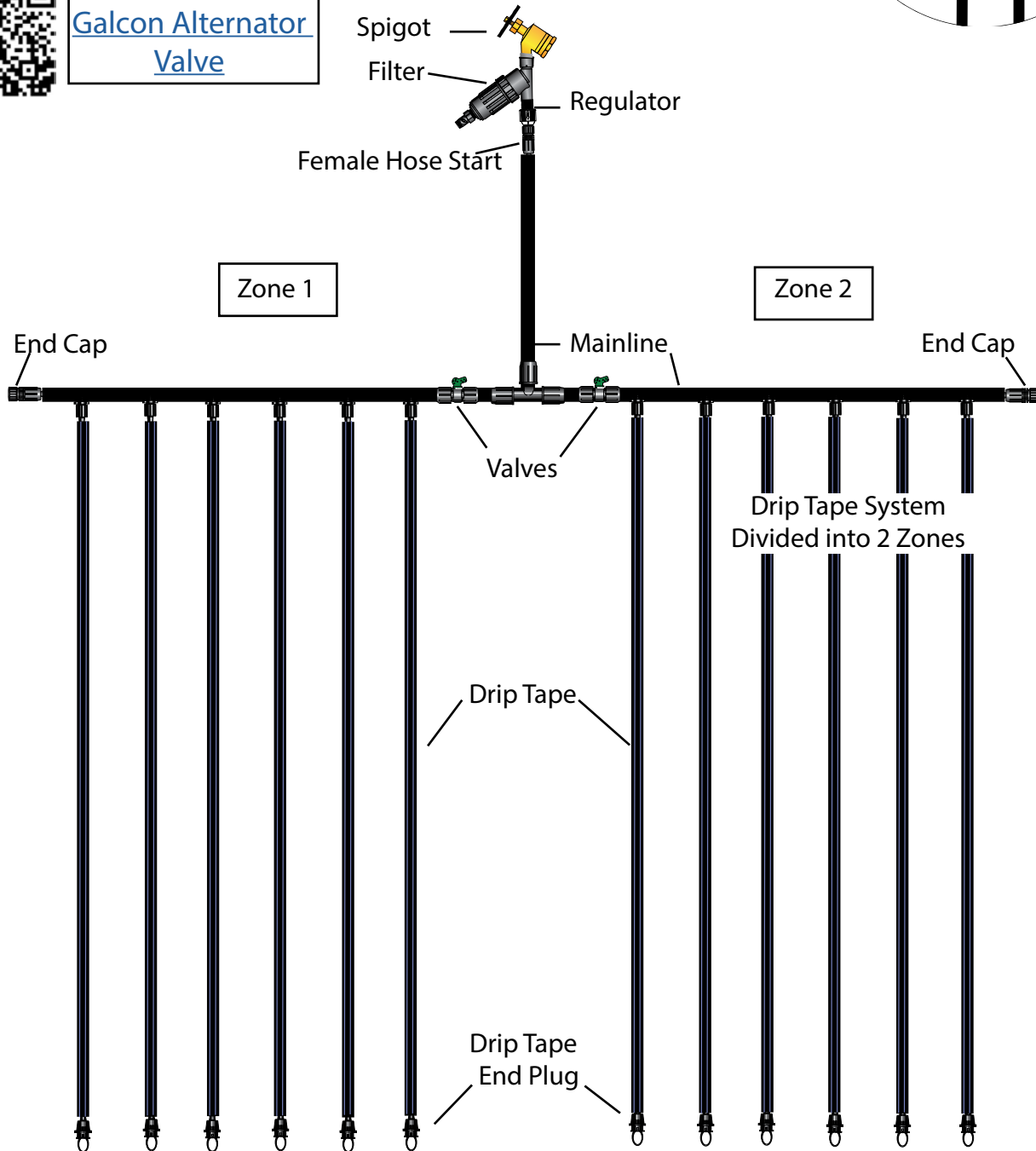
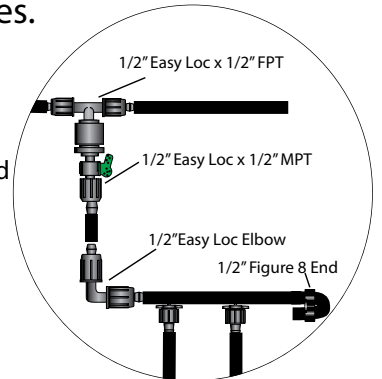

Emitter Tubing (DET) Connections

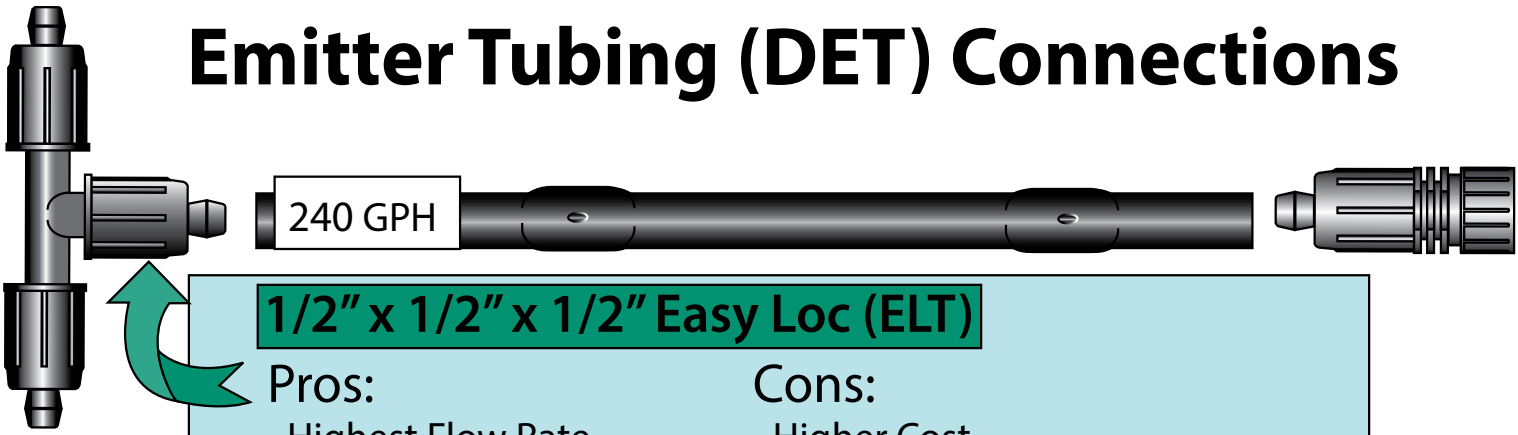

1/2" x 1/2" x 1/2" Easy Loc (ELT)

Pros:

- Highest Flow Rate
- Most Stable
- Most Versatile

Cons:

- Higher Cost
- Multiple Points of Connection

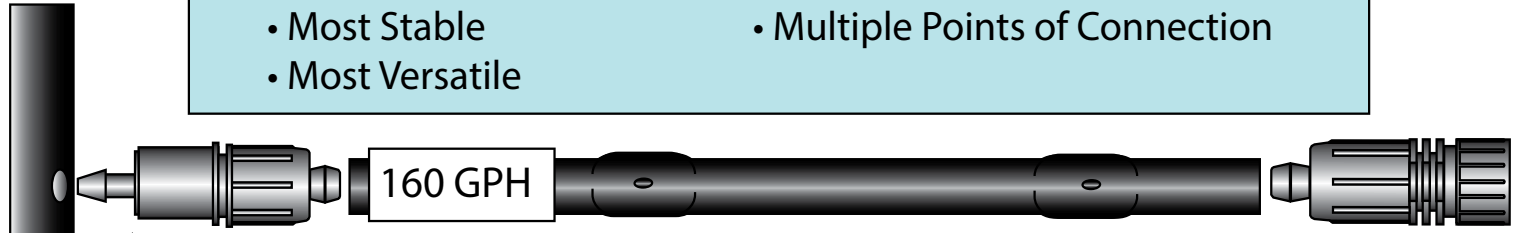

1/2" Easy Loc x .400" Barb (EL38B)

Pros:

- Higher Flow Rate (than EL14B)
- Single Point of Connection
- Shutoff single line (EL V400B)

Cons:

- Less Stable (than ELT)
- Less Versatile (than ELT)
- Requires a .400" Punch

.400" Barbed Fittings require 3/4" or larger mainline tubing

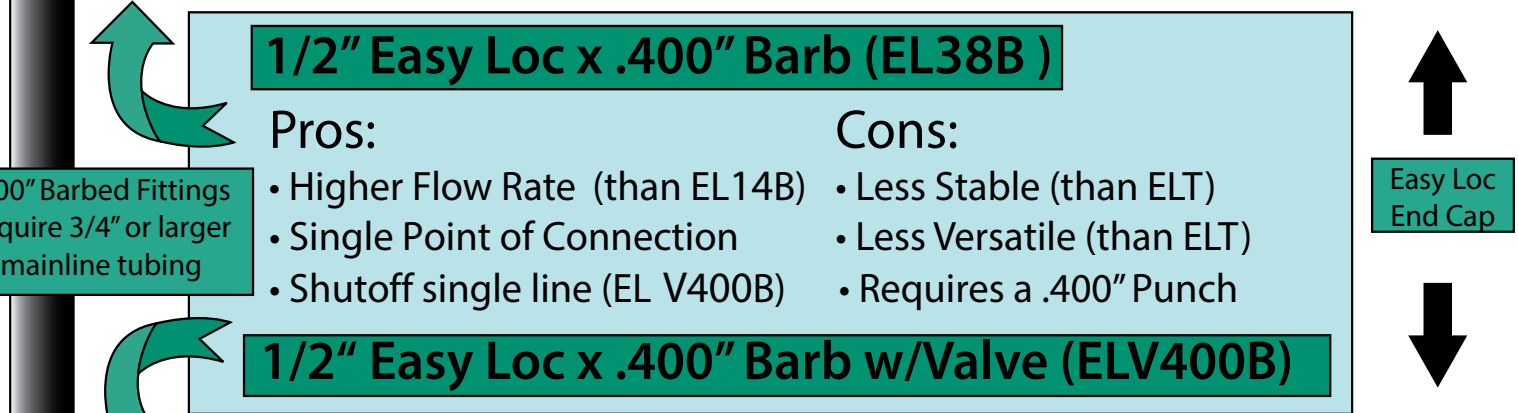
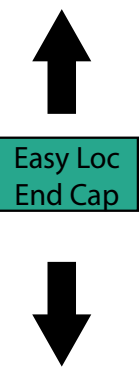

1/2" Easy Loc x .400" Barb w/Valve (ELV400B)

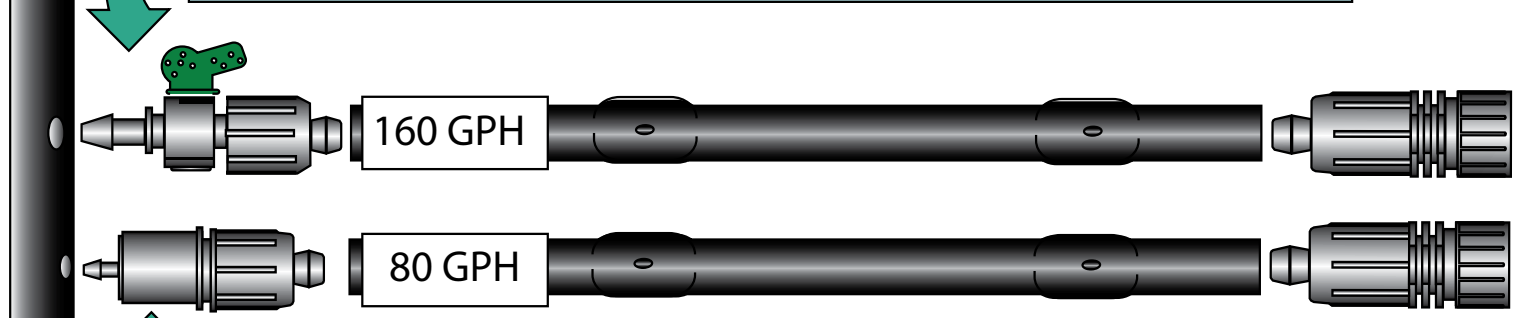

1/2" Easy Loc x 1/4" Barb (EL14B)

Pros:

- Lower Cost
- Single Point of Connection

Cons:

- Low Flow Rate
- Less Stable (than ELT)

[1/2" emitter tubing](#) is available with a variety of spacings, roll lengths and the 9" and 12" spacing offer 1/2 GPH or 1 GPH options.

1/2" Emitter Tubing Around a Tree

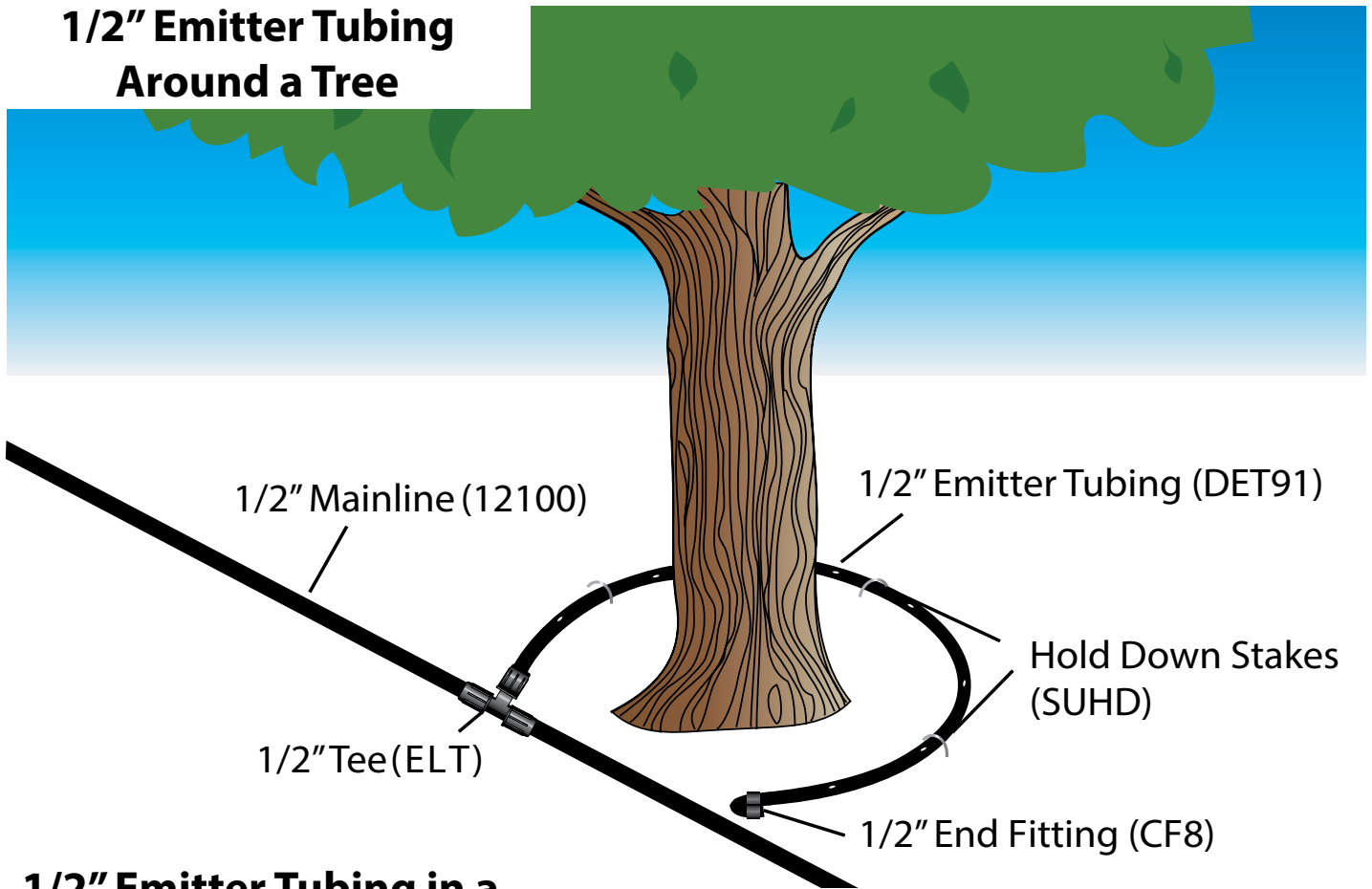

1/2" Emitter Tubing in a Framed and Raised Bed

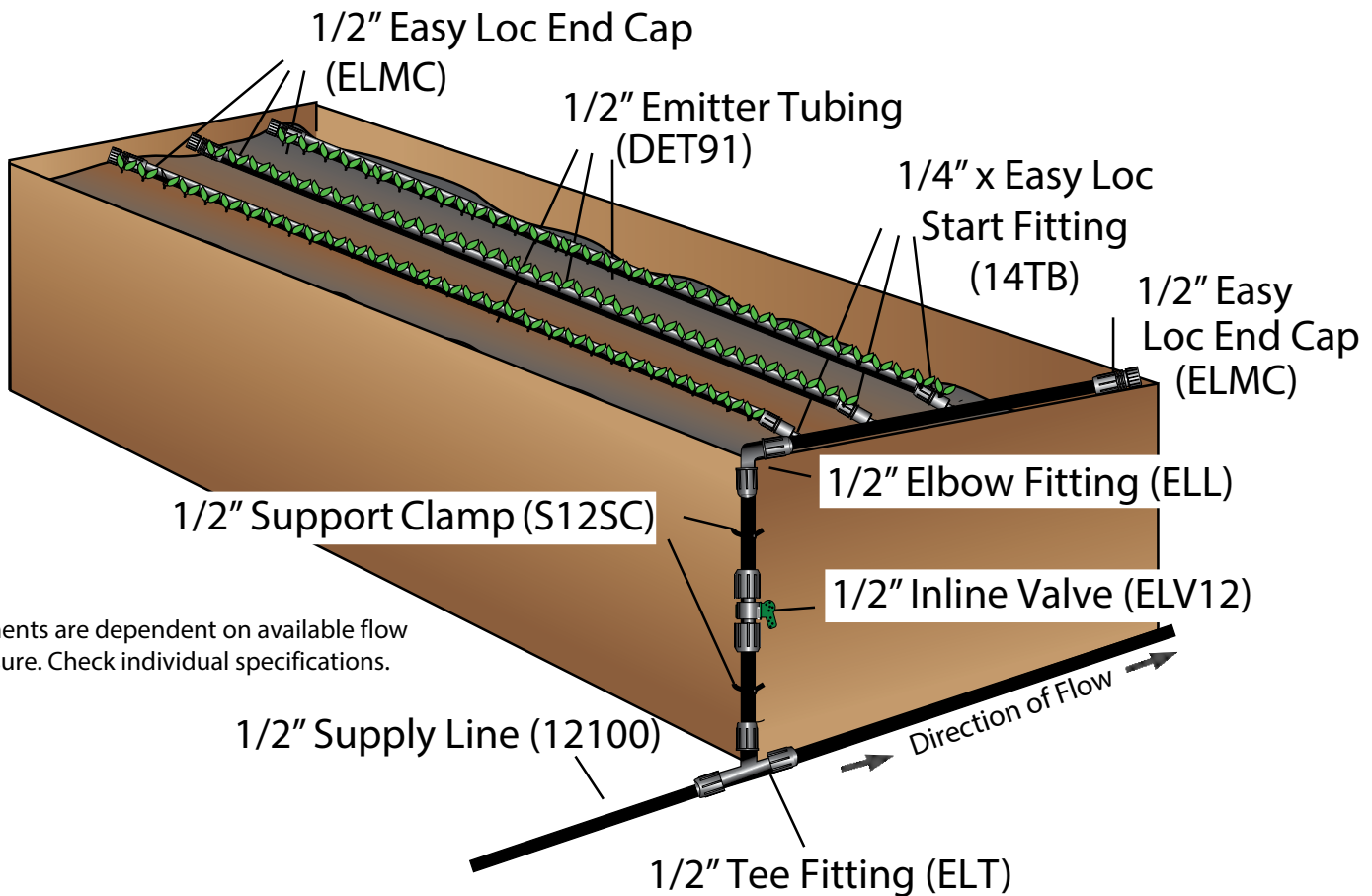

*Components are dependent on available flow and pressure. Check individual specifications.

Drip Tape Connections

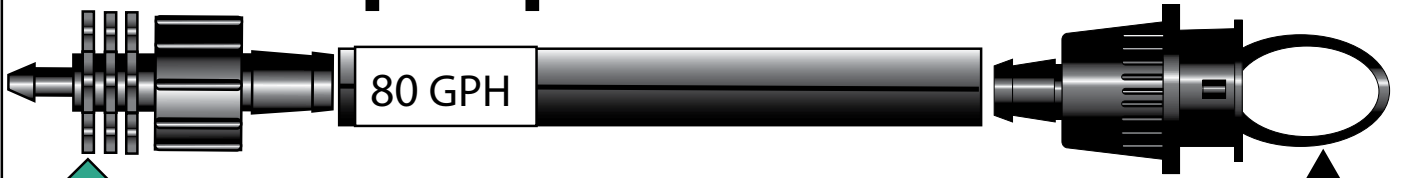

Tape Loc x 1/4" Barb (LSB)

Pros:

- Lowest Cost

Cons:

- No Shutoff
- Lower Flow (than LSB400)

Drip Tape
End Plug

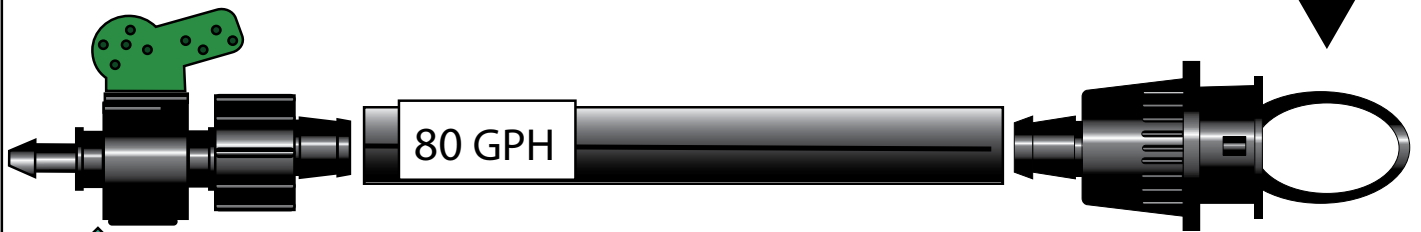

Tape Loc x 1/4" Barb w/ Valve (LSBSO)

Pros:

- Shutoff Valve

Cons:

- Higher Cost (than LSB)
- Lower Flow (than LSB400)

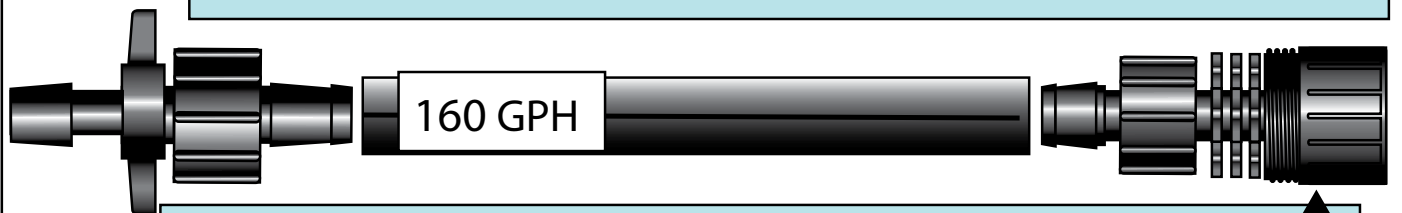

Tape Loc x .400" Barb (LSB400)

Pros:

- Higher Flow (than LSB)

Cons:

- Higher Cost
- Requires Special Punch
- No Shutoff

Drip Tape
End Cap

.400" Barbed Fittings
require 3/4" or larger
mainline tubing

Tape Loc x .400 w/Valve and Tape Loc x .420 Barb w/Grommet (for PVC).
More [Tape Loc Fittings](#) are available online.

1/4" & 1/8" Connections

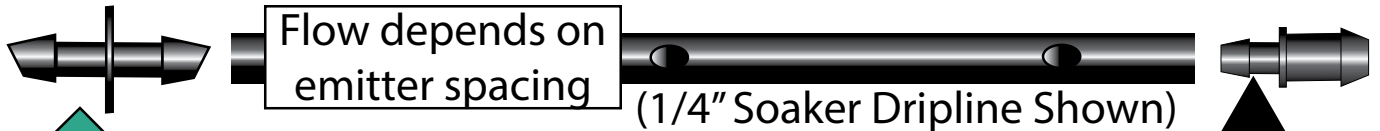

1/4" Transfer Barb (14TB)

Pros:

- Inexpensive

Cons:

- Limited Flow

1/4" End Plug or Emitter



1/4" Long Transfer Barb (14LTB)

Pros:

- Inexpensive
- Easier to Grip (than 14TB)

Cons:

- Limited Flow

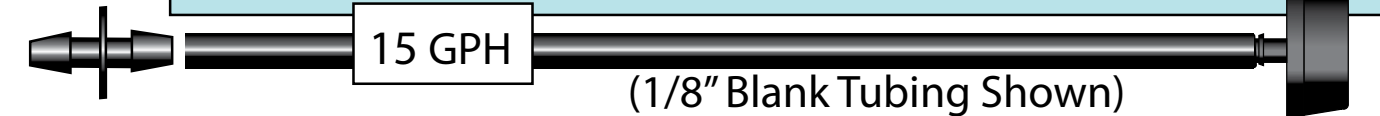

1/8" Transfer Barb (18TB)

Pros:

- Very Inexpensive

Cons:

- Requires 1/8" punch
- Very Low Flow
- Limited Applications

Emitter
(No 1/8" End Plug Available)

Other 1/4" Fittings

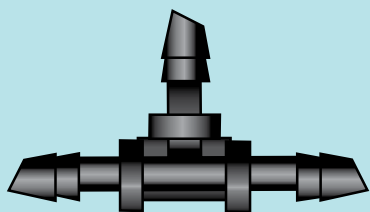

1/4" Tee (14T)

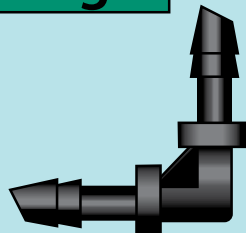

1/4" Elbow (1490)

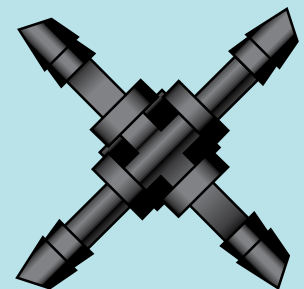

1/4" Cross (14X)

More [tubing](#) and [fitting](#) options are available online.

1/4" Soaker Dripline in a Raised and Framed Bed

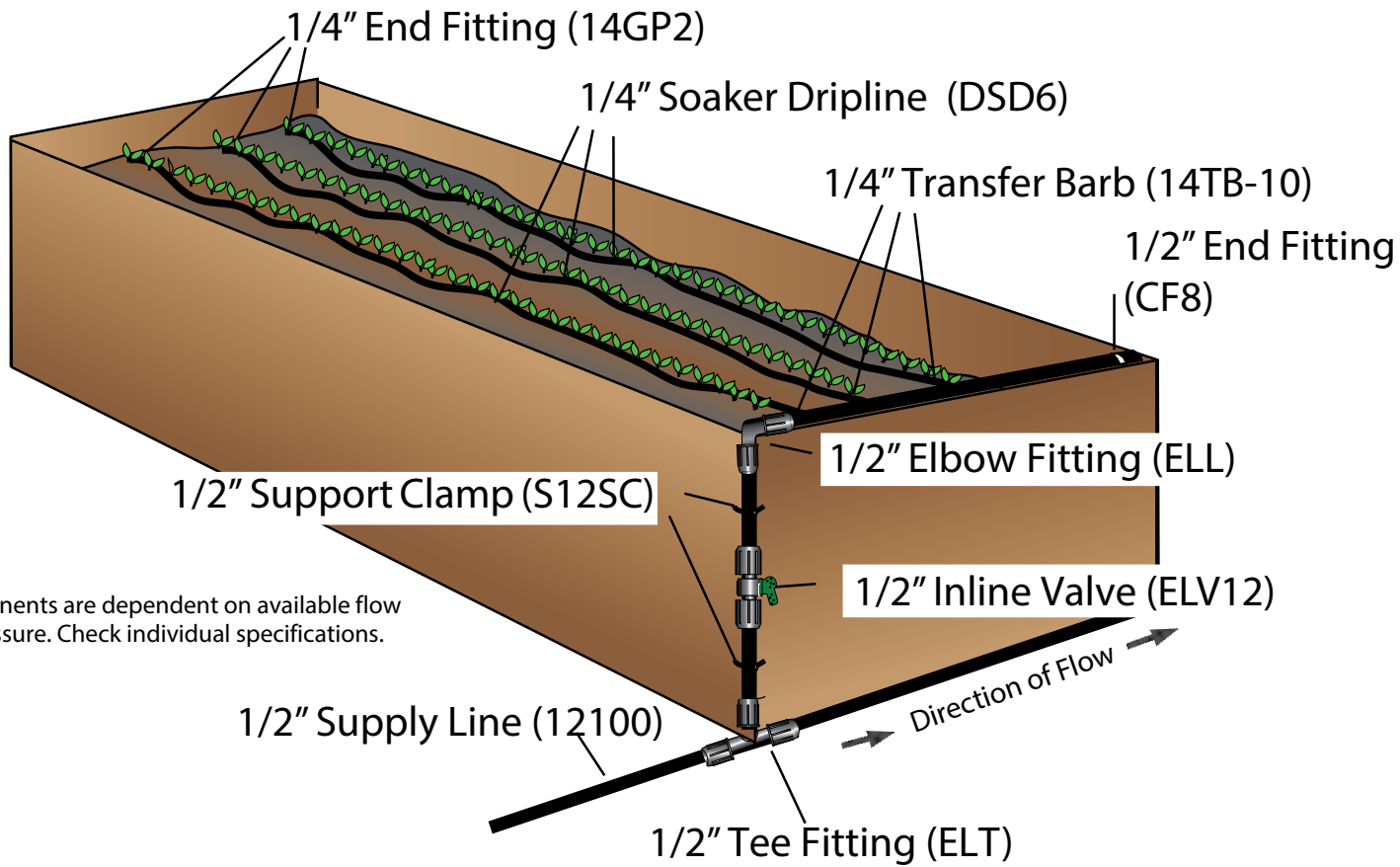

1/4" Soaker Dripline in a Container

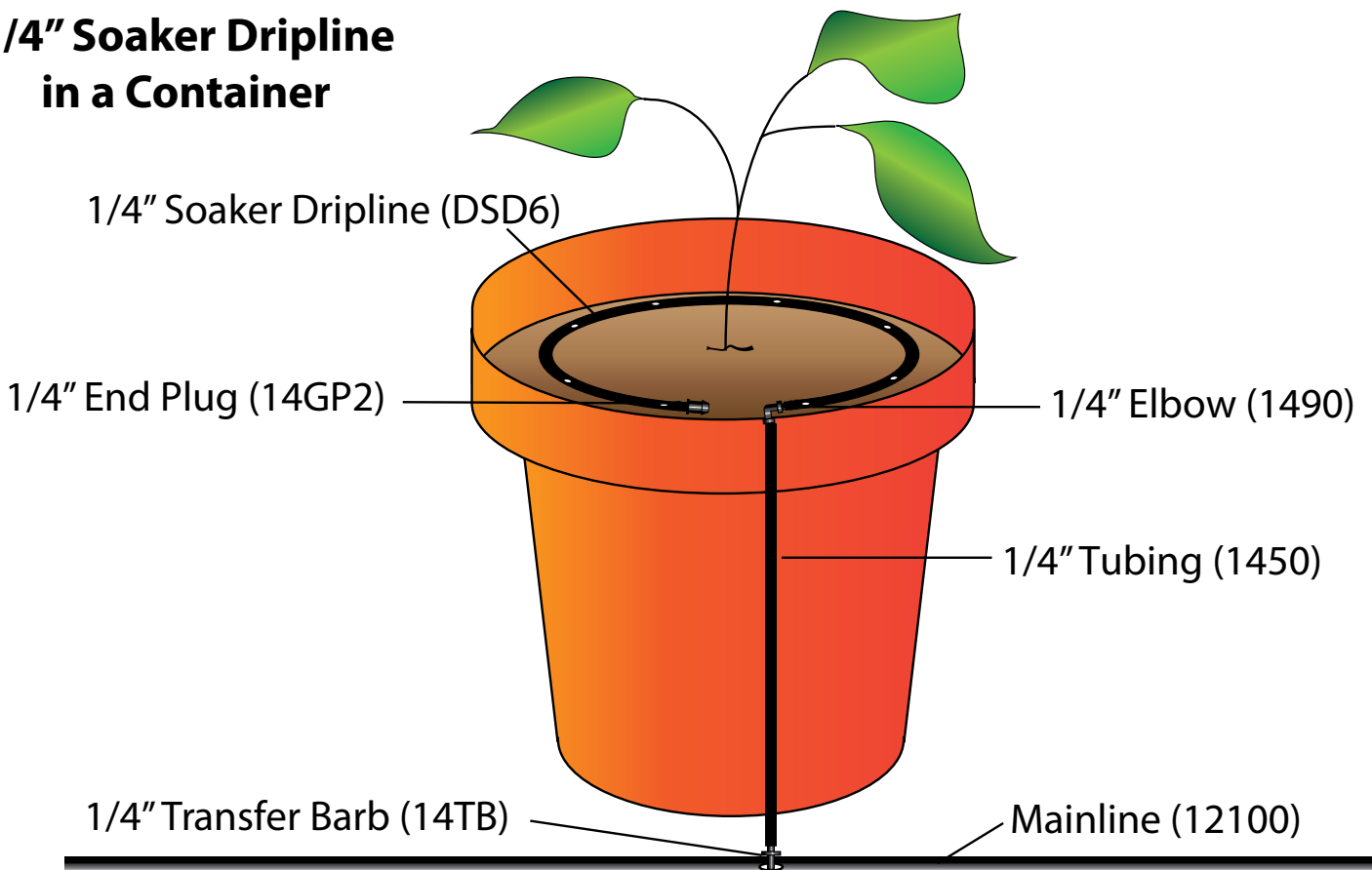

1/4" Soaker Dripline around a Small Tree or Bush

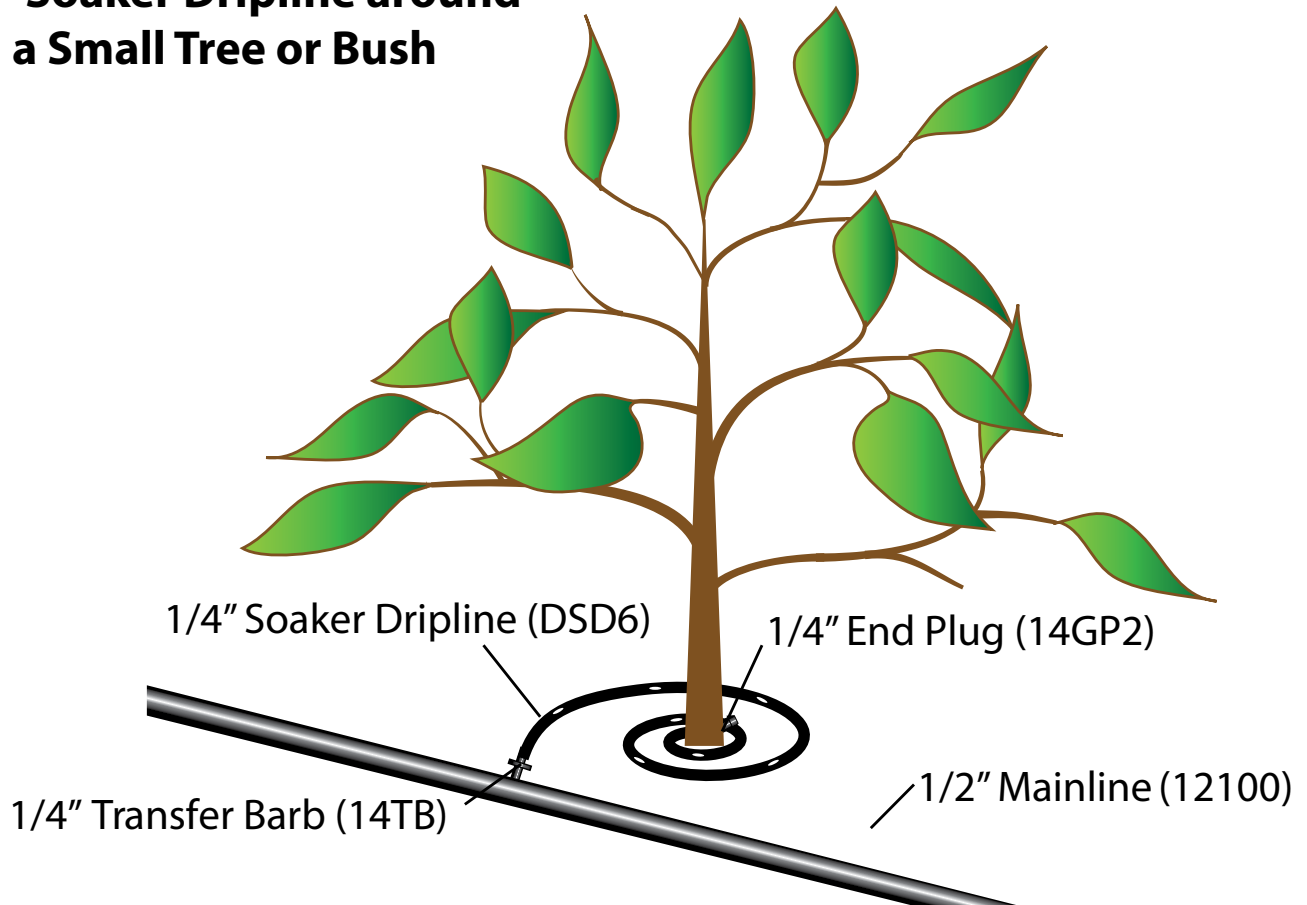

1/4" Soaker Dripline in a Planter Box

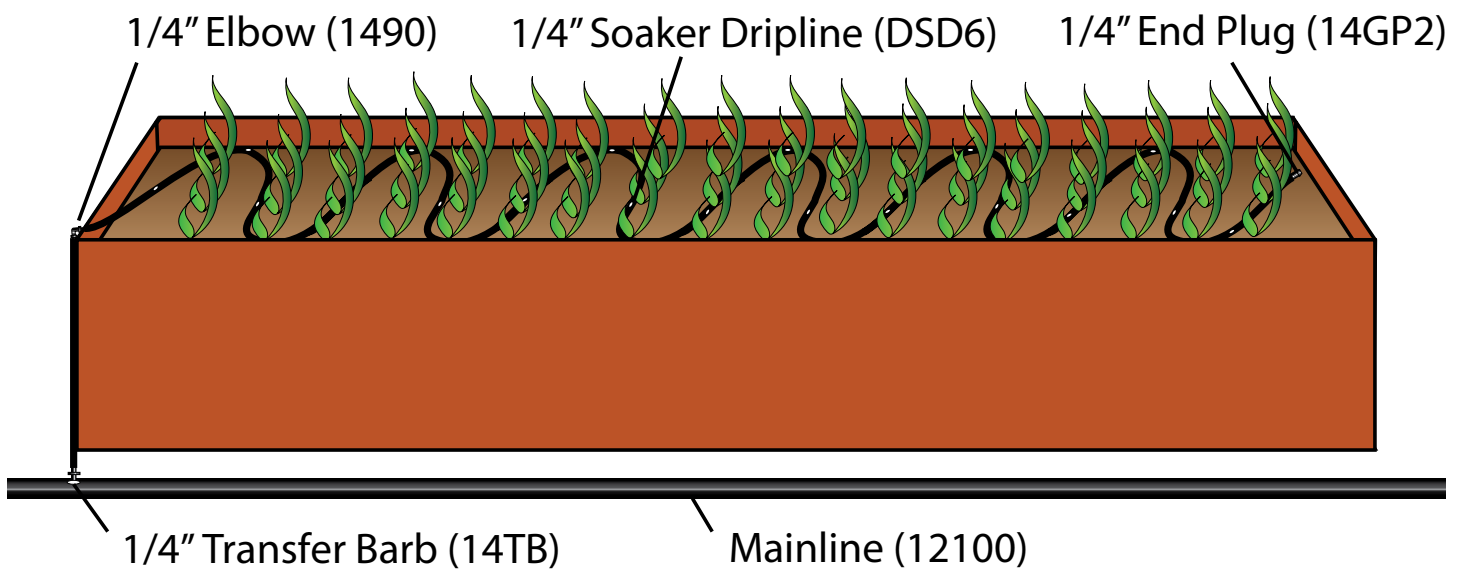

Basic Emitters (Non-pressure-compensating)



[Take-Apart Emitters](#) have a locking cap that can be removed for cleaning. The 1/4" barb inlet can be inserted into a hole punched into the mainline tubing or attached to the end of 1/4" micro tubing. The beveled barb end is the inlet and the flag end is the outlet. 1/4" micro tubing can also be attached to the outlet of the emitter to reach plants that are farther away. Available in 1 GPH, 2 GPH, and 4 GPH.

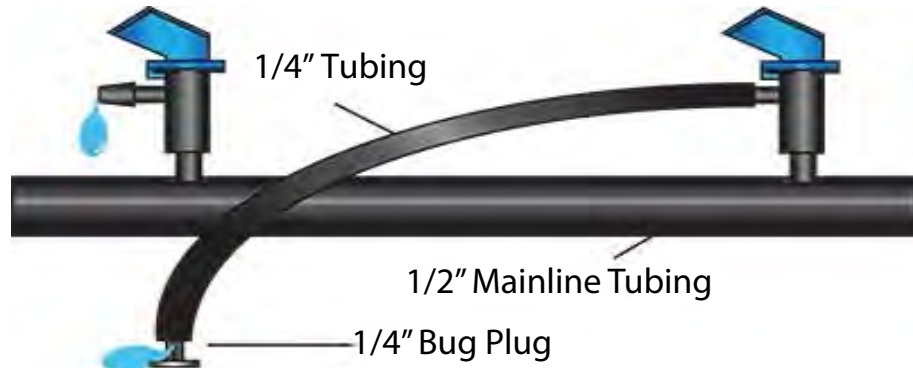

[Shrubblers](#)® emit streams of water that can be adjusted from 0-24" diameter (we recommend 15"). This large spray pattern covers the root zone and helps to water in fertilizers and nutrients. They are adaptable to different sizes of plants and changing water needs. Shrubblers® can be individually shut off with a simple twist of the cap.

Also available mounted on a 5" stake.

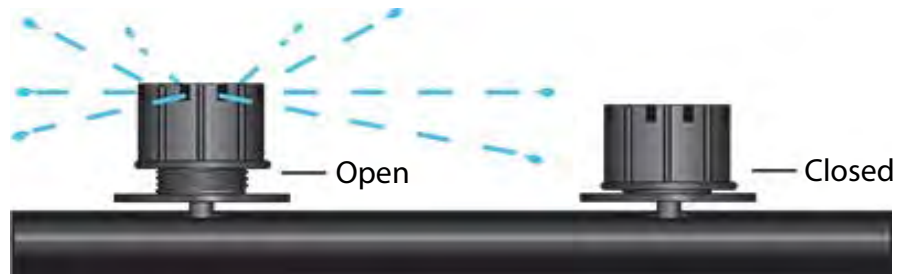

If you have a very dirty water supply (pond or irrigation ditch) where a fine screen filter clogs quickly, this may be the answer. Use a coarse screen filter (30-50 mesh) for large particles and the [Non-Stop Emitter](#) will pass particles that would plug almost any drip emitter. A minimum of 15 PSI is required for these emitters to work properly. Use at the end of 1/4" tubing or installed directly into the mainline. Will emit 1 GPH at 20 PSI.

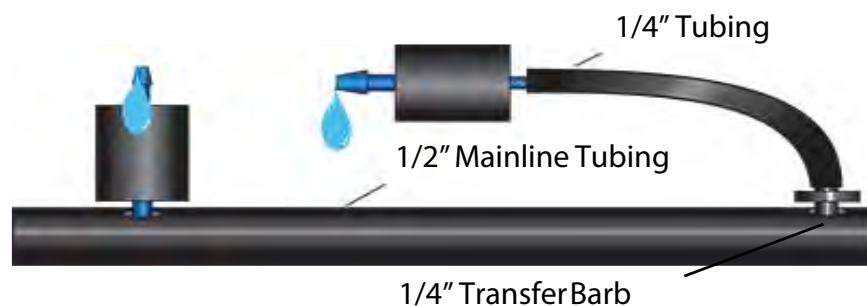



Use these [Mini-Inline Drippers](#) when you want to make your own inline emitter tubing out of 1/4" micro tubing. Great for unevenly spaced plants, or where multiple emitters are needed for larger plants. It's also easy to add these drip emitters into existing 1/4" lines at any time.

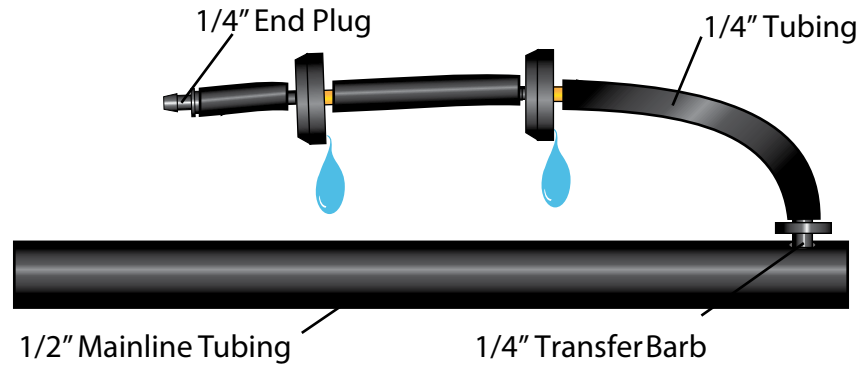

[Pot Drippers](#) are basic drip emitters with a 2" hold down stake and a 1/4" threaded inlet. The attached 2" stake pins them securely in place without the need for a hold down. Pot Drippers are great for small to medium size containers.

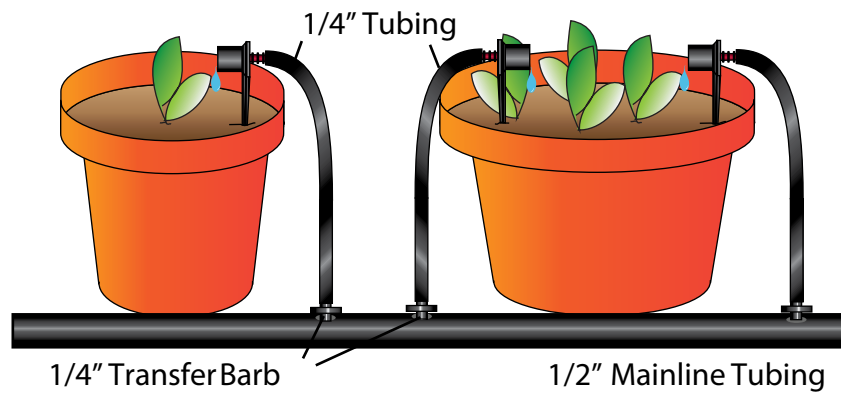

Pressure-Compensating Emitters



These [Woodpeckers](#) are heavy duty pressure compensating emitters. They have been the product of choice for many years in the rugged vineyards of Northern California. They have a 1/4" inlet and outlet and their EPDM rubber diaphragm is the largest available and least likely to plug. Pressure range is 15-50 PSI.

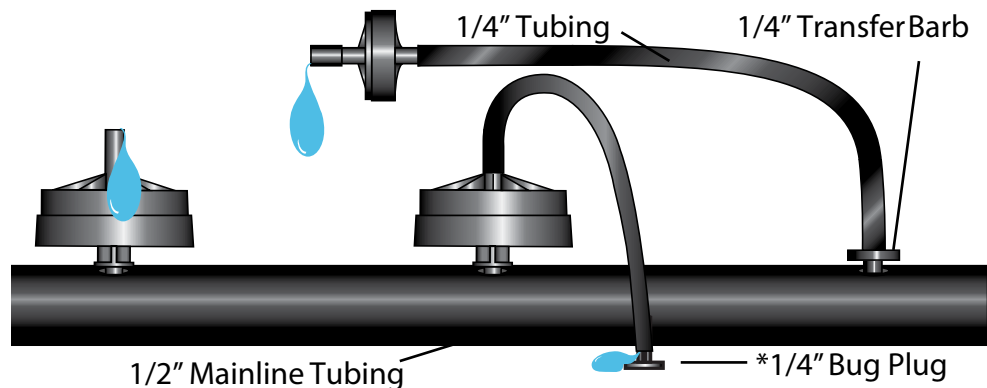

3 Ways To Install
a Woodpecker or
Woodpecker Jr

*Optional



[Woodpecker Jr.](#) emitters are designed specifically for even watering and are perfect for commercial applications. They have a non-draining check valve that opens and closes at 7 PSI. Every emitter in the system starts and stops at the same time giving off the same amount of water to prevent under or over watering at the beginning and ends of the lines (or in low areas of the system). They have a 1/4" inlet and outlet and a pressure range of 10 - 50 PSI.



The low-flow, pressure compensating [Sideout Dripper](#) has an internal diaphragm and check valve which allow for consistent flow rates at higher pressures. The check valve ensures that all emitters on the line open up at the same time (when the pressure reaches 10 PSI) and close at the same time (3 PSI). Their pressure compensating range is 20 - 50 PSI and their flow rate is 1/4 gallon per hour (GPH). They have a 1/4" barbed inlet that allows them to be inserted directly into the mainline tubing or at the end of 1/4" micro tubing and a 1/8" barbed outlet so 1/4" or 1/8" micro tubing can be attached to reach plants that are farther away from the mainline.

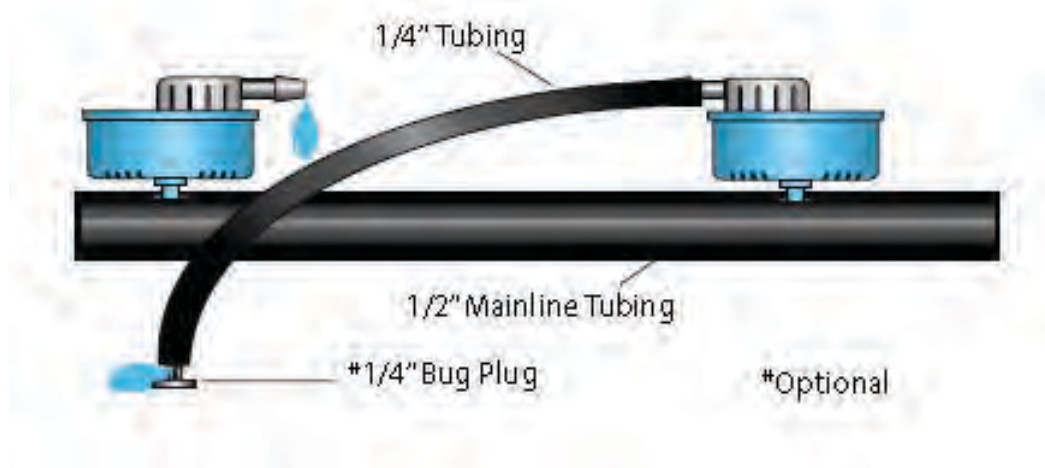

No 1/8"
Plug Available



[Vibra-Clean](#) emitters have a low profile to help protect against damage from weed-whackers and foot traffic, making them ideal for commercial landscape plantings. The screened inlet resists clogging and the tapered base allows for easy insertion and the DOVTOOL saves time, effort, and your fingers!

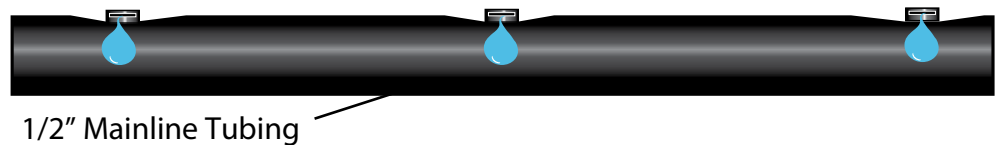



The [Pressure Compensating Shrubber](#) has a gentle flow action with uniform coverage for all emitters on the same supply tubing line. Although pressure compensating, there is some variation due to pressure. They have fixed flow rate, a colored cap for easy identification, and can be taken apart easy cleaning. Pressure range is 15 to 50 PSI. **Also available on a 5" stake**

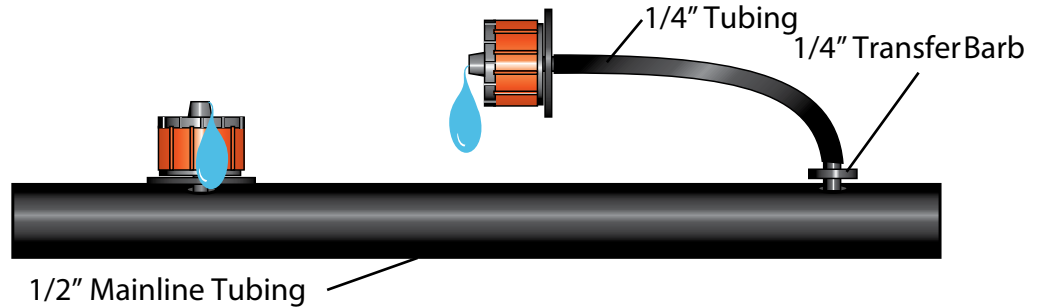

The [Pinch Drip](#) emitter lays flat on the mainline tubing so that it's not easily damaged. They are designed for easy "finger or thumb installation". The emitters have a 1/4" barbed inlet and a 1/4" nipple outlet and can be used in containers, on patios and in landscapes. They are UV stabilized for longevity and have a self-flushing turbulent flow emitter. Pressure range is 15 to 50 PSI

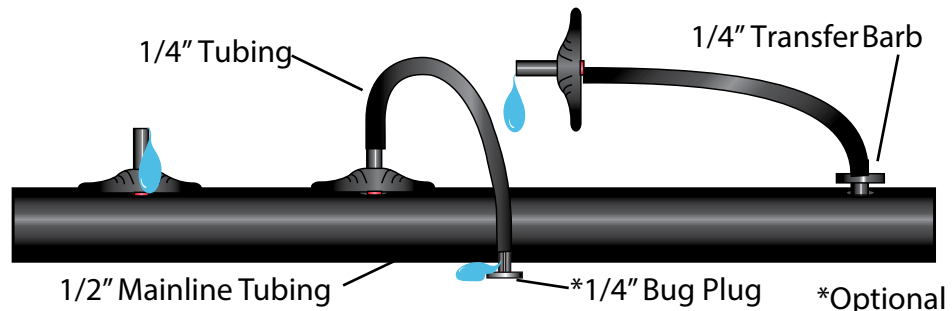

[CETA PC Emitters](#) are pressure compensating emitters that come apart for easy cleaning. They are available in 3 different flows and they have 1/4" barbs on the inlet and outlet. All of these emitters operate in a pressure range of 10 to 50 PSI. **Also available on 4" stake.**



PC Emitters on Stakes



PC Shrubbler

The Pressure Compensating Shrubbler has a gentle flow action with uniform coverage for all emitters on the same supply tubing line. Although these are pressure compensating, there is some variation depending on your starting pressure. Pressure Range



Cobra Stake Emitter

The Cobra Stake Drip Emitter is a landscape spike dripper that delivers precise amounts of water directly to the root zone of the plant. It also commonly used for watering small to medium size containers, balled root stock, and landscape applications. Pressure Range 15-45 PSI



CETA Inline Emitter

These are the only in-line emitters available that are pressure compensating. The in-line emitters are all 1 GPH and they can be taken apart for easy cleaning. They have 1/4" barbs on the inlet and outlets. Up to 15 of these in-line emitters can be run on a single line of 1/4" tubing. All of these emitters operate in a pressure range of 15 to 45 PSI.



Support Stakes for Sprinklers, Sprayers, & Misters



Supernet Stake

This 13" blue stake is designed to elevate and support a Supernet Sprinkler Assembly



Press-Fit Support Stakes

These complete press-fit support assemblies are used to elevate press-fit sprinklers (Ein Dor, Wing, or Tornado Misters) above your plantings. They include a plastic stake or metal rod, press-fit bridge, 1/4" tubing, and a transfer barb.



With a length of [Rigid Riser](#) or 1/4" tubing the stakes below will accommodate Mini-Jets, Micro Jets, and Vari-Rotors as well as the base versions of the Spectrum Sprayer, Bubbler, and Shrubblers. They will also support Mini-Misters, Tornado Misters, and Cool Breeze Misters



Straight Stake

The main body of this stake has a groove which will hold either our 1/4" polyethylene tubing or Rigid Risers (will not work with our 1/4" vinyl tubing). This design makes the stake less visible and thus more attractive in flower and show gardens.



Clip Stake

This plastic stake has a clip to hold either Rigid Risers or 1/4" tubing. The clip has an outside diameter of .285", slightly over 1/4" (.250"). If needed, a single course of tape around the 1/4" tubing will create a snug fit.



Elbow Stake

This 7" stake has a control valve to easily adjust the flow and distance of spray from a Mini Jet sprayer or any other sprayer. The threaded top accepts a short length of 1/4" tubing or Rigid Riser between the stake and the sprayer. Barb on the side accepts 1/4" tubing from the mainline.



Angle Stake

Use a short length of Rigid Riser or 1/4" tubing (up to 2") to connect a mister or sprayer to the top of these stakes. Attach to the mainline with 1/4" tubing and a 1/4" transfer barb.



Using the Manifold Start Valve and Add-on Valve

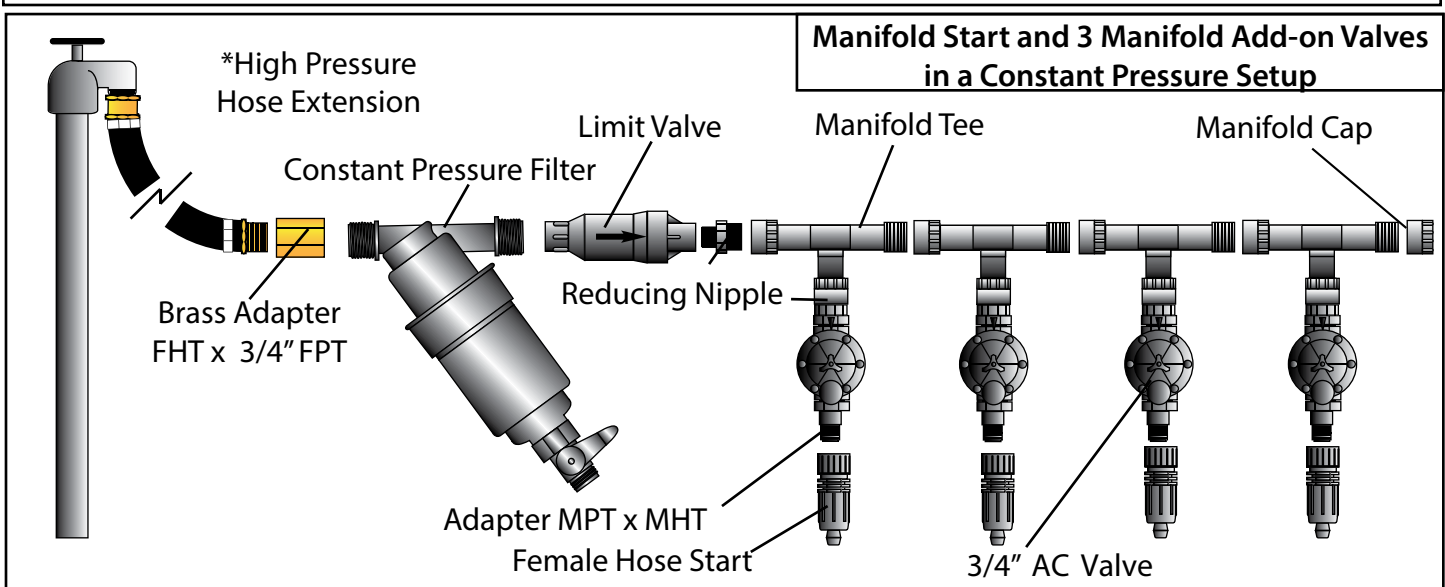
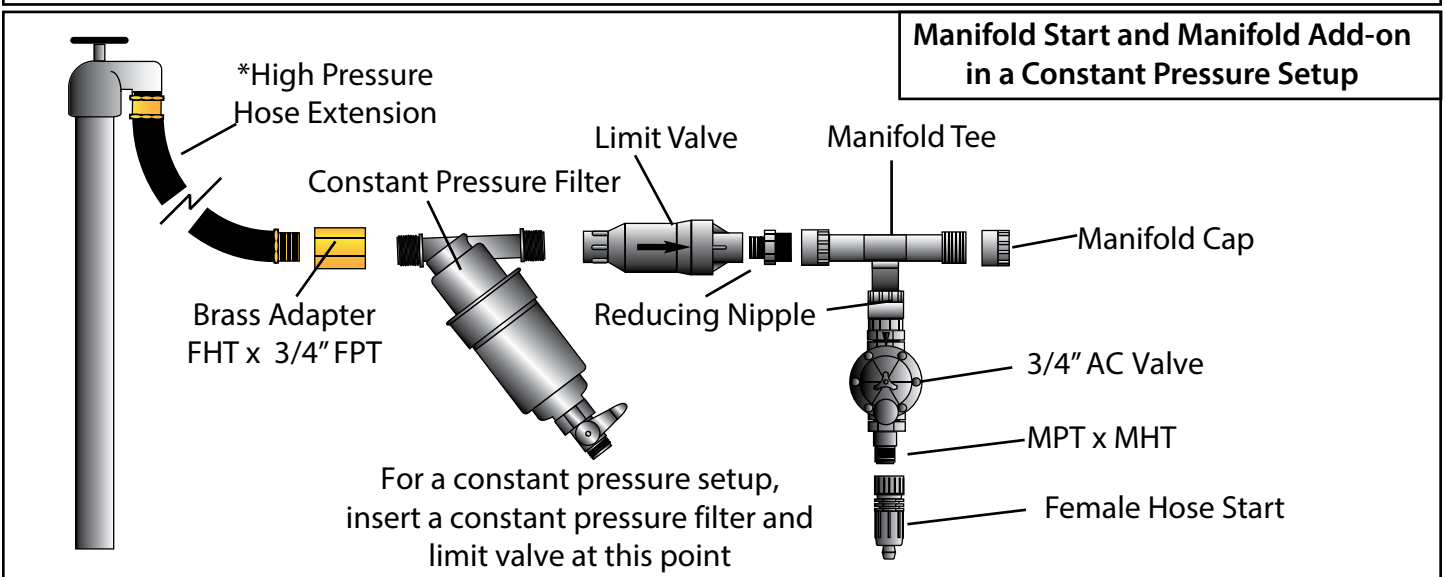
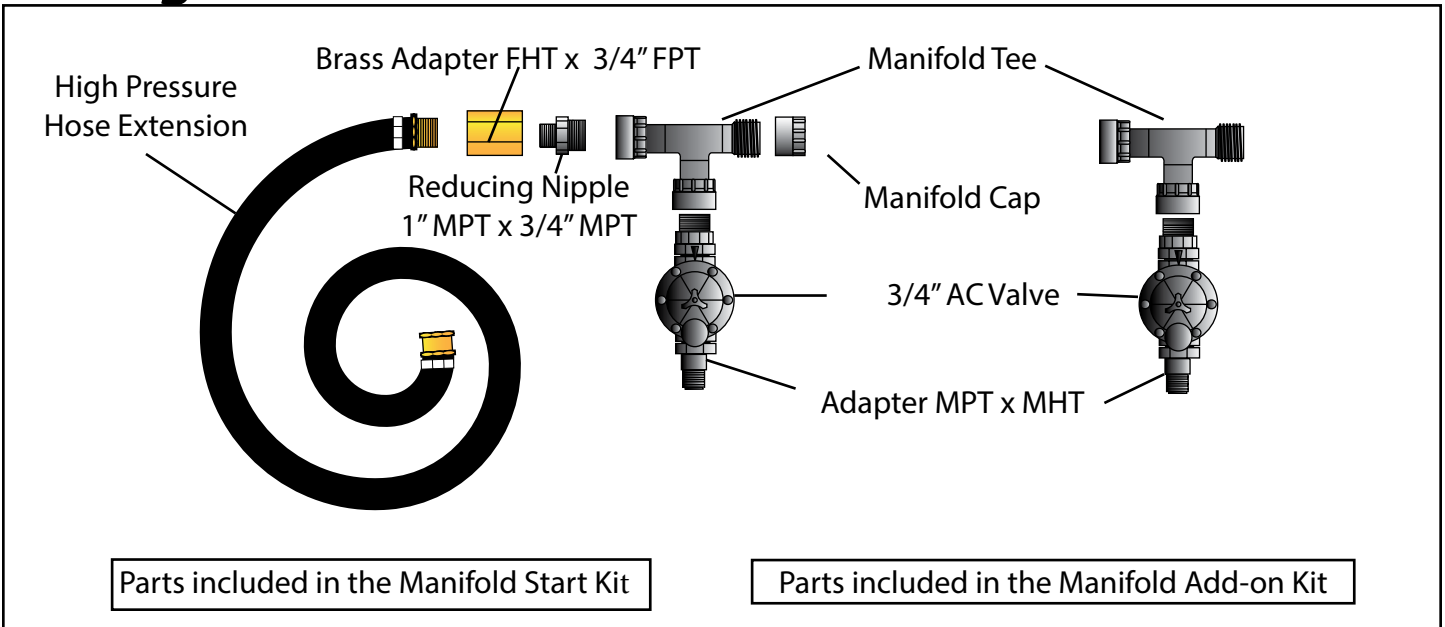

**Note: The factory-installed brass adapter on the hose extension is tightly threaded. If desired, the constant pressure filter and limit valve can be installed before the hose extension.*

Greenhouse Overhead Misting Setup

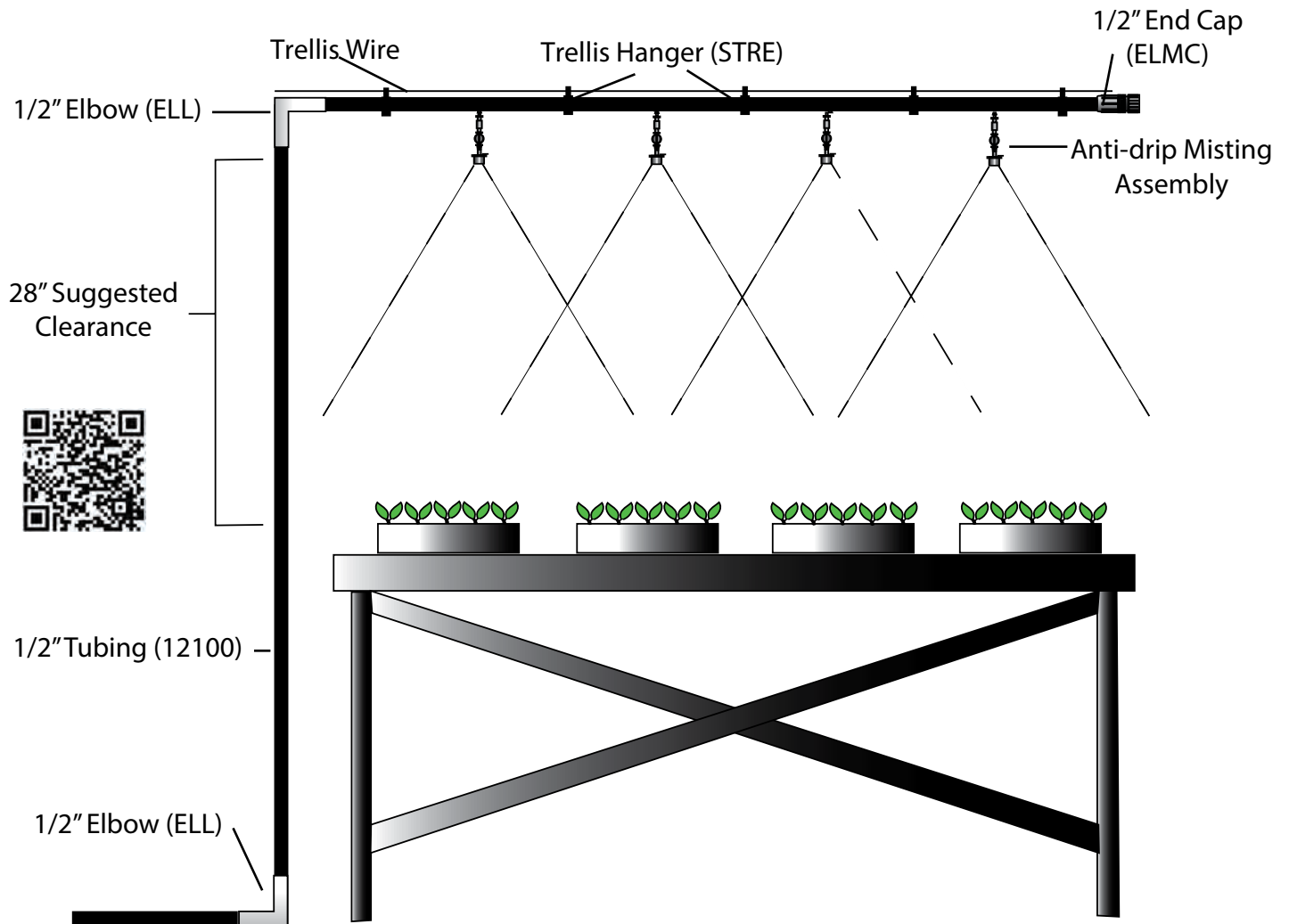

Greenhouse Watering Options

There are several product options to consider when setting up a greenhouse watering system. Inverted Tornado Mistors or Ein Dor Mini-Sprinklers are a great choice for small to medium size greenhouses. Inverted Mini-Wobblers are designed to water larger greenhouses. 4-way Foggers and Tornado Mistors are ideal for seed propagation and boosting humidity in any size greenhouse.

Seed Propagation Tip

If the distance between the propagation table and the misters is too great or alignment becomes a problem, the mister can be extended by inserting a transfer barb and a length of flexible 1/4" vinyl tubing between the overhead supply line and the misting assembly then hanging a weight from the line.

Anti-drip Misting Assembly

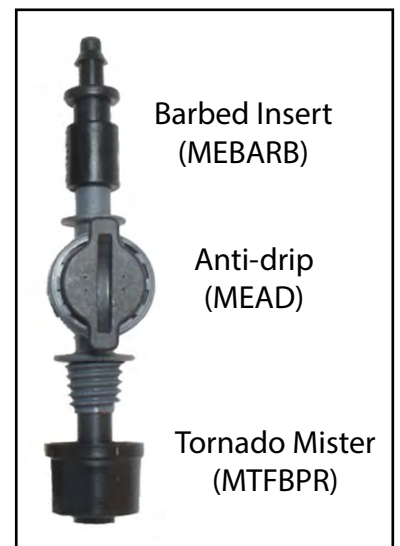

Sprinkler to Drip Conversion

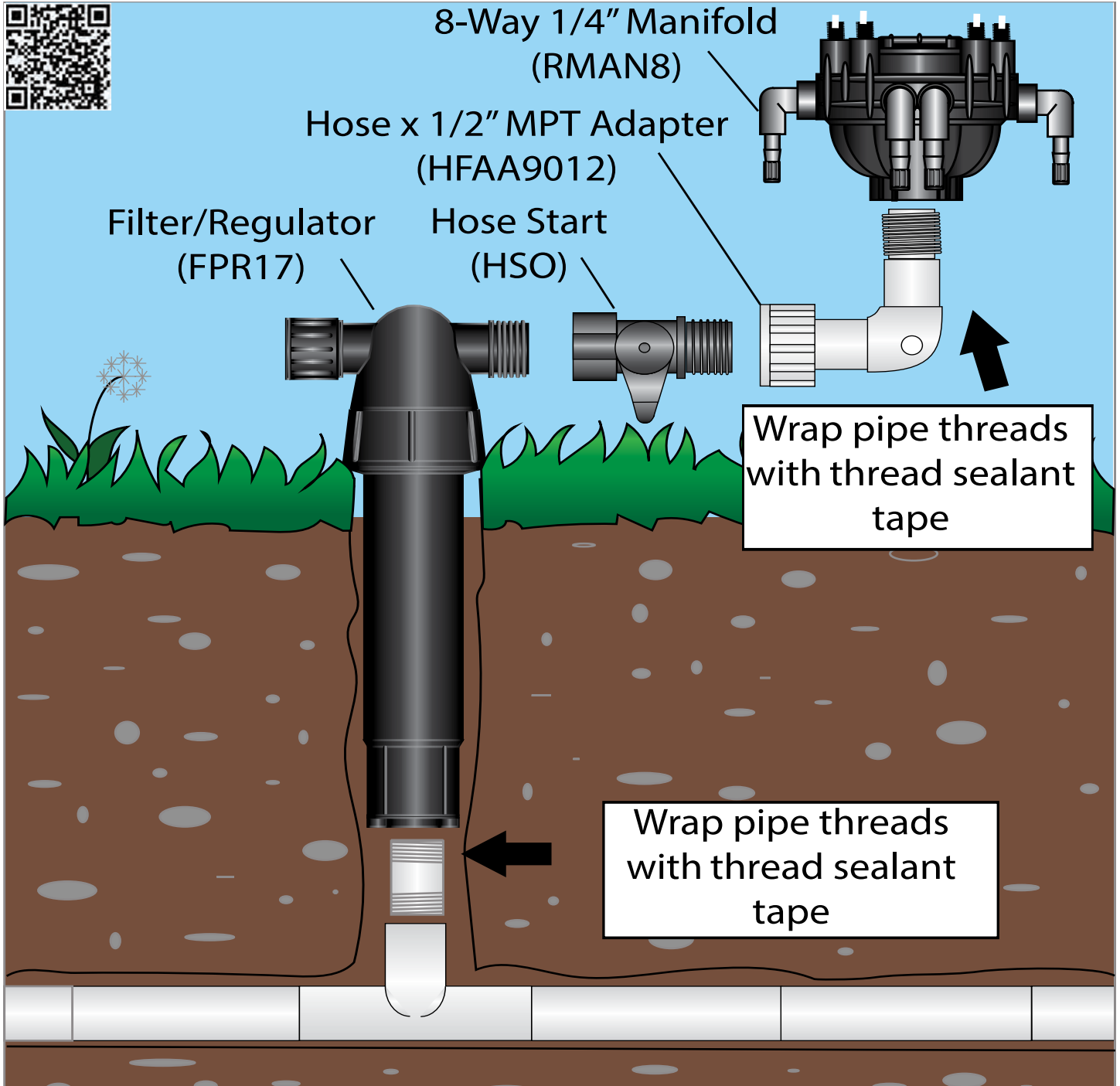

8-Way Sprinkler to Drip Conversion Kit (KVC1)

This sprinkler to drip kit converts a single pop-up sprinkler head to drip irrigation. The filter/pressure regulator unit has a 1/2" FPT inlet that connects to a 1/2" MPT riser and a fully adjustable manifold to direct the flow through eight separate 1/4" outlets for an almost endless variety of configurations. Ideal for any combination of containers, spot gardens, herb beds, or isolated plantings. An internal screen filter protects against clogging downstream and a master shutoff valve and individual shutoffs at each outlet give complete flow control.

Can be expanded to cover double the area.

Sprinkler to Drip Conversion

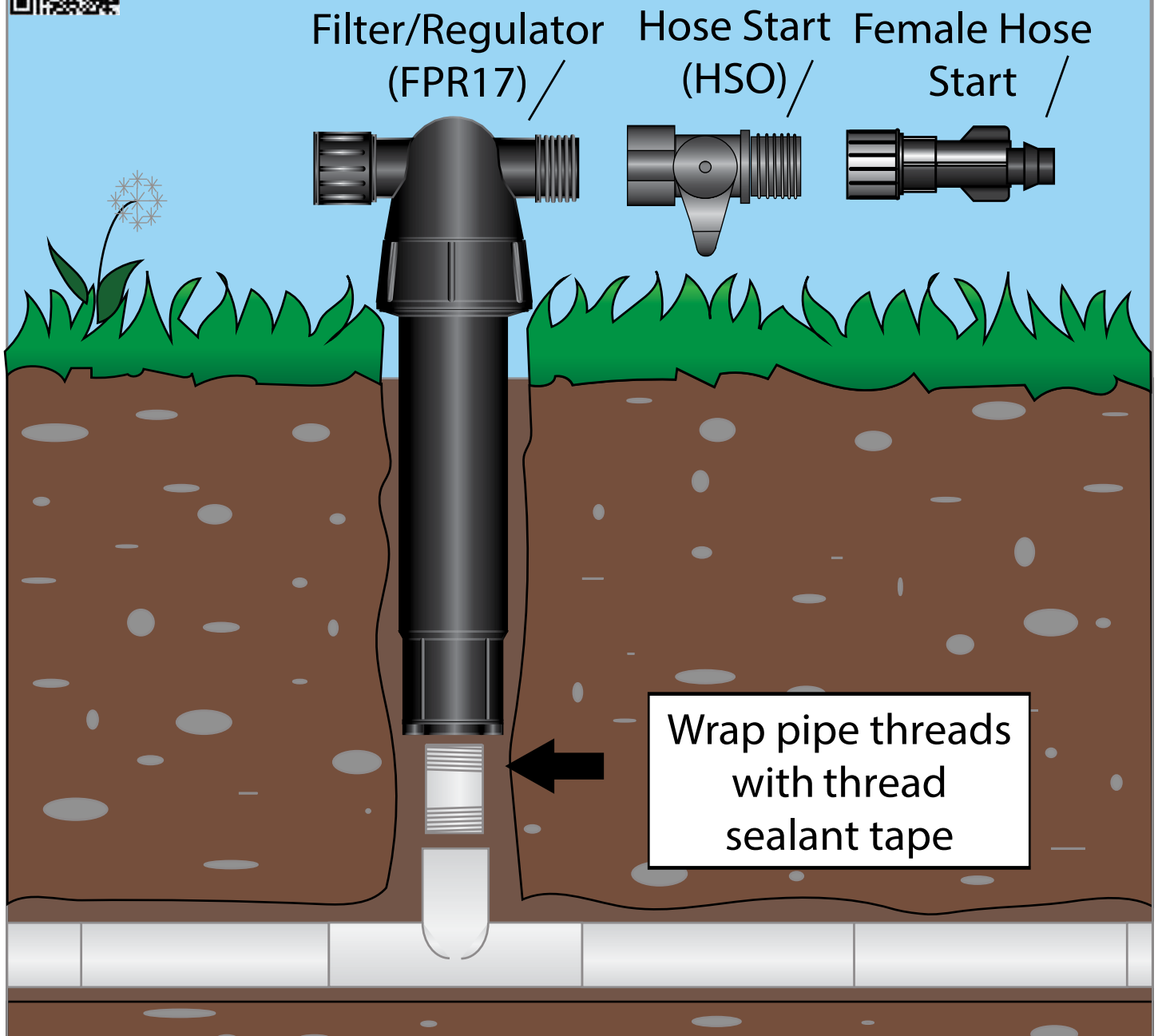

1/2" Sprinkler to Drip Conversion Kit (KVC2)

This sprinkler to drip kit converts a single pop-up sprinkler head to a drip irrigation mainline. The filter/pressure regulator unit has a 1/2" FPT inlet that connects to a 1/2" MPT riser that accepts hose thread fittings which provide a connection point for 1/2" mainline tubing. The included 1/4" fittings and 1/4" Soaker Dripline can be configured to fit almost any situation. Great for containers, garden beds, and isolated plantings.

Can be expanded to cover double the area.



Air Bleed Valves

Drip tape installations on sloped terrain, systems with radical elevation changes, and long tree lines over 500' can develop air locks in the system. Installing an [air bleed valve](#) at the system's high points can help to eliminate those air locks and keep buried lines from back suctioning dirt and debris that can clog supply lines and emitters.

1" Air Bleed Valve 3/4" Air Bleed Valve 1/2" Air Bleed Valve

Minimum activation pressure is 5 PSI
Maximum working pressure is 80 PSI

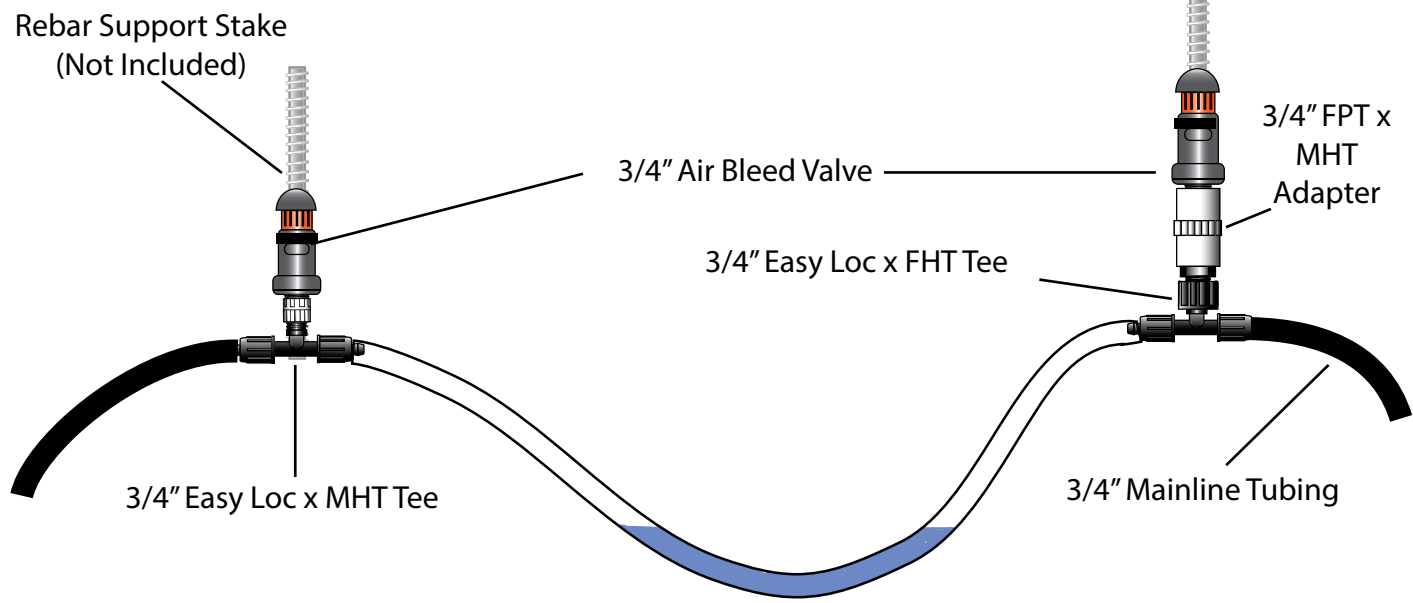
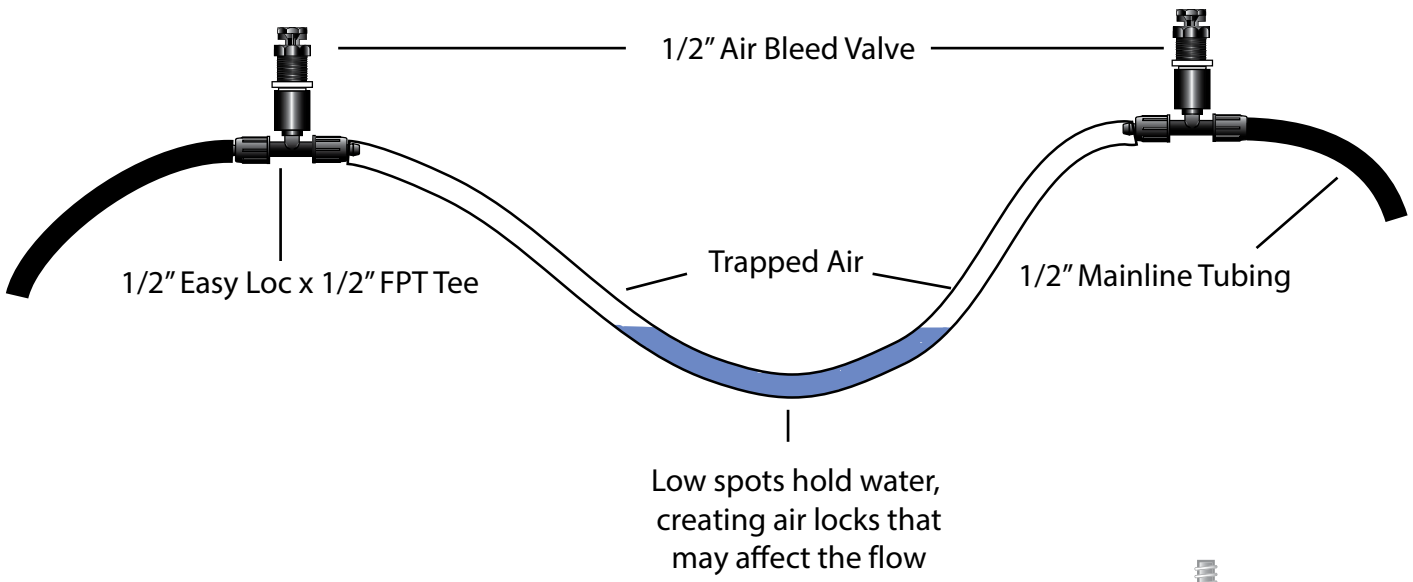

Fertilizer Injectors

Fertilizer injectors are the most efficient way to feed plants, delivering nutrients in a liquid form directly to the roots of your plants. Fertilizer injectors are a fast and accurate way to feed an entire garden, landscape, nursery or greenhouse. Injectors range from the simple EZ-FLO units to the commercial-grade MixRite pump style fertilizer injectors, with the Mazzei suction style injectors falling in between.



EZ-FLO injectors are the most economical, flexible and easy to use injectors ever! Made of commercial-grade components, these injectors are ideal for backyard gardeners, commercial landscapers and small farms. Just fill the tank, with dry fertilizer or a concentrated liquid fertilizer, set the adjustment valve, and voila!



The MixRite fertilizer injector reliably meters fertilized solution into your line and is solely powered by the water moving through it. Select the model with the desired fertilizer dilution concentration (mix ratio) for the fertilizer or additive that you are injecting into your line.

Mazzei fertilizer injectors are commercial-grade, Venturi injectors with no moving parts to wear out or break down. They work by suction, and can draw liquid fertilizer from virtually any container. The Mazzei can be plumbed on a bypass for less restriction (the preferred method), or directly into a main water line.

Timers/Irrigation Controllers

If you're not there to turn the water on, or sometimes forget to turn it off and run up your water bill, a drip irrigation timer can be a great investment. A timer will turn your system on and off at designated times to give your plants the steady, consistent watering they need for optimum health and production.

Battery (DC) Timers

Battery Timers are relatively inexpensive and will fit the needs of most home garden situations. Hose threaded and easy to install and program, they are typically limited to one valve. **High End Battery Timers** are commercial-grade battery timers and more costly, but can operate multiple pipe threaded DC valves.

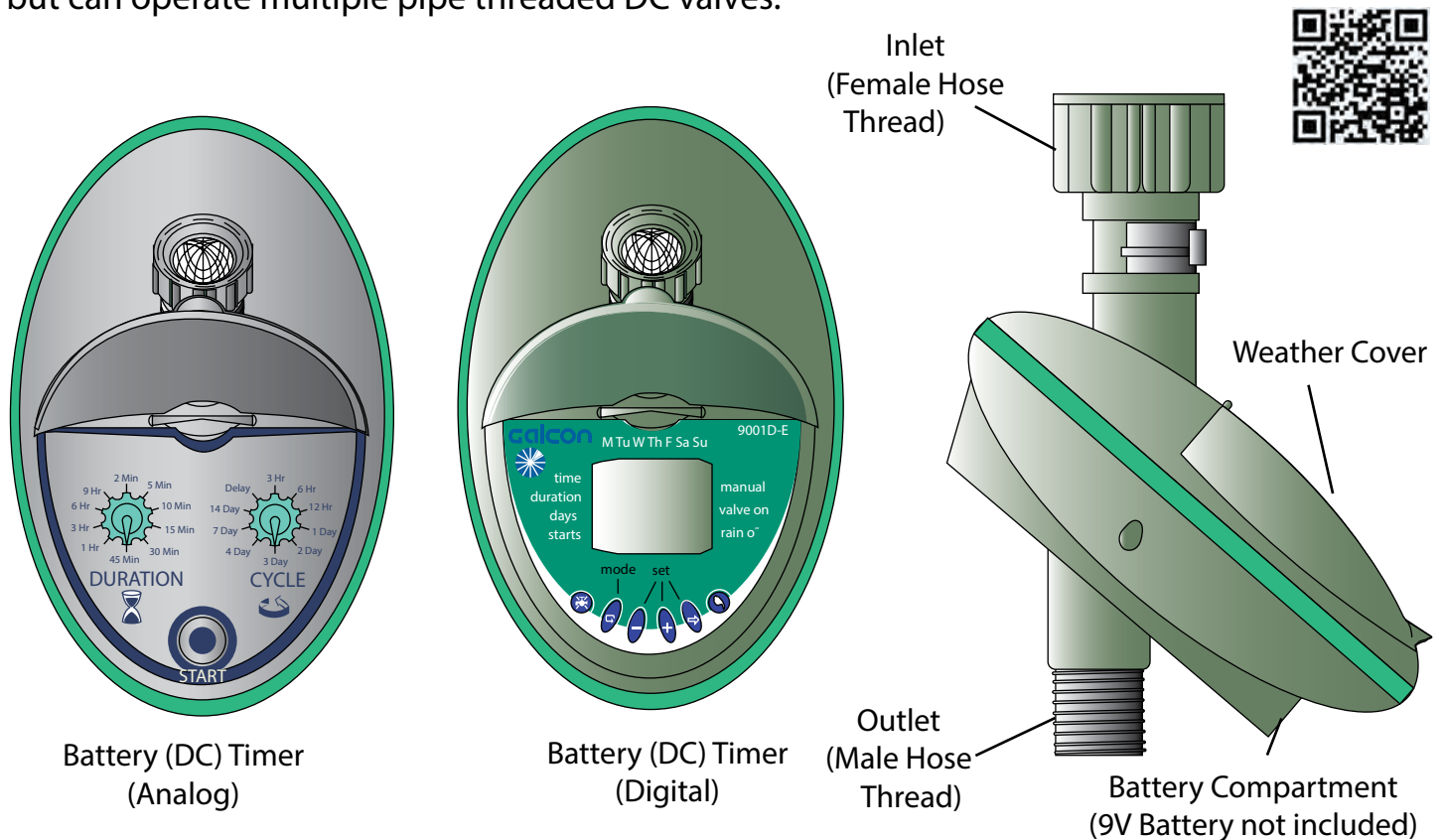

Analog battery timers (see 2 dial model above, right) may lack the bells and whistles of its digital counterpart, but require no “programming” and are extremely simple to use. Just turn the duration dial to how long you want to water, turn the cycle dial to how often you want to water, then hit the start button. From that point on, the timer will come on at the same time on the days you choose.

Digital battery timers often have multiple start times, rain sensors, and other features as well as an LCD screen to view all your programming options. If you're looking to water more frequently, or using an Alternator Valve to split your system into watering zones, this is the type of timer for you.

Electric (AC) Timers

Electronic Timers (aka **Irrigation Controllers**) come in a variety of sizes, but are usually designed to operate multiple 24 volt AC valves and require an AC power source.

Electric Timers (aka **Irrigation Controllers**) base units can be sold with a set number of stations or with modules that allow you to expand to more with each zone controlled by its own valve. They often offer several programs with individual start times and extras like rain sensors, pump start relays, and master valve controls, making them ideal for larger installations such as farms, greenhouses, nurseries, vineyards, and landscapes. If your situation has different plantings with differing watering requirements, or is larger (can be divided into 1 or 2 zones), this is the kind of timer you will want.



6 Station Electric
Greenhouse Timer



4 Station Electric Timer
Available in Internal or
External Models



Electric Timer available
in 4, 6, or 8 Station
Models

Electric Greenhouse Timers are a special subset of electric timers that, in addition to multiple start times and programs, might offer watering durations down to 1 minute or, for seed propagation purposes, 1 second increments. If your high tunnel or greenhouse has multiple zones, and/or seed propagation tables, check out the specifications for this type of timer before you buy.

Other Timers

Solar Timers are a great alternative to a battery or electronic timer. Powered by ambient light, they require no back-up power source, and are perfect for remote gardens.

Wind-Up Timers are an inexpensive alternative to a battery or electronic timer and considered "cheap insurance" for those who forget to turn the water off.

Filters

Filters remove sediment and debris that can clog an irrigation system. We offer a variety of filters to meet the unique needs of your system. Select a filter based on the quality of your water supply and the size of your system. We recommend installing a filter on every irrigation system and will not warranty a system without an appropriate filter installed.

Screen Filters (Hose Thread)



Screen filters remove sediment and debris that can clog a drip system. These Home Garden Screen Filters are commonly used for small to medium size irrigation systems with a relatively clean water supply (municipal source or a clean well). These filters are not rated for use under constant pressure and should be placed after automated valves and timers.



'Y' Type Filter



'T' Filter



Inline Filters

Disc Filters (Pipe Thread)



Arkal Disc filters are designed to remove organic matter (algae) from your water supply. They are commonly installed when using surface water (pond, creek, canal, reservoir) for irrigation.



Super 'T' Filter



Dual Lite 'T' Filter



'Y' Type Filter

Constant Pressure Filters

Small Constant Pressure Filters



Amiad Tagline filters are the low cost solution for constant pressure situations, their reinforced bodies and o-rings allow them to be installed before timers or valves. They are ideal for removing sediment and debris in irrigation systems with multiple zones as they can be placed before a manifold.



Large High Pressure Filters



These standard Amiad filters have a stainless steel screen with a heavily reinforced frame. Standard Amiad filters can handle higher pressures than the Amiad Tagline Filters.

Multi-Zone Constant Pressure Setup

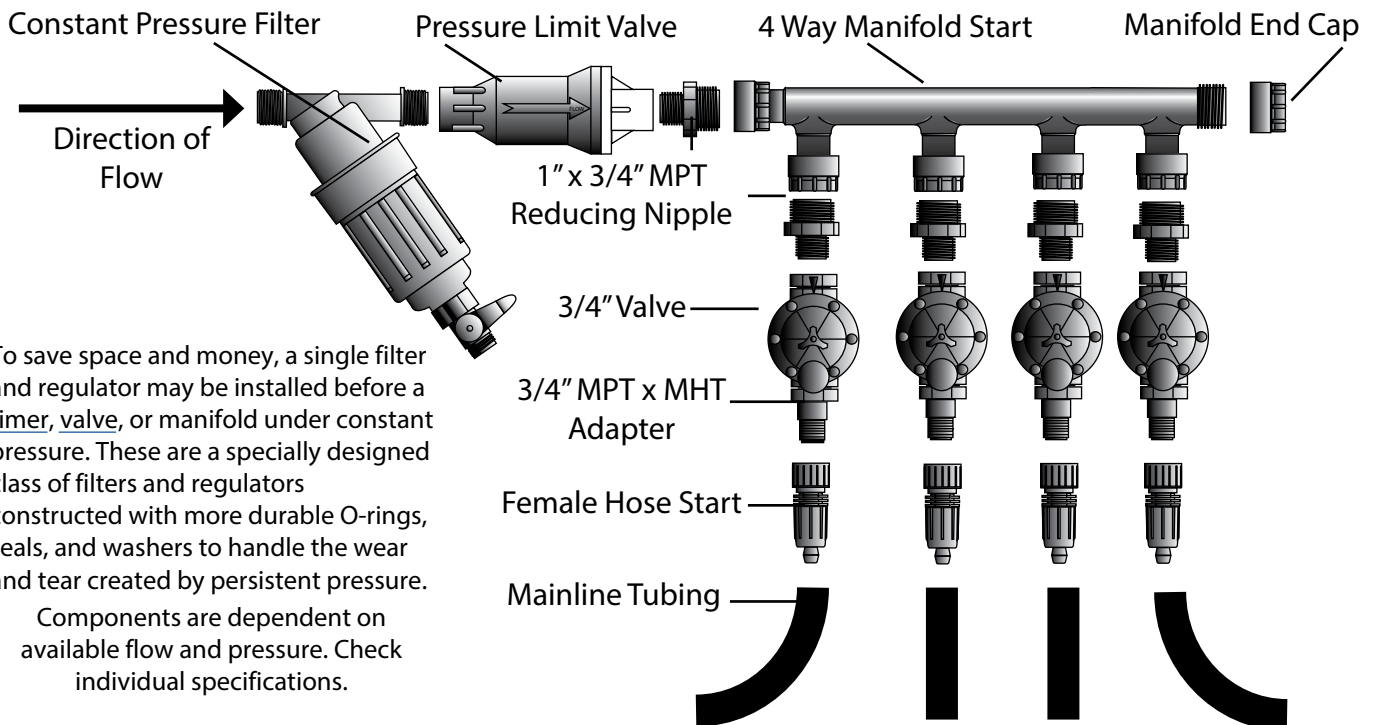

To save space and money, a single filter and regulator may be installed before a timer, valve, or manifold under constant pressure. These are a specially designed class of filters and regulators constructed with more durable O-rings, seals, and washers to handle the wear and tear created by persistent pressure. Components are dependent on available flow and pressure. Check individual specifications.

Large Filters



Super "T" Screen Filter

The 2" Amiad Super "T" constant pressure filters have a double size screen which allows for longer lengths of time between cleanings. Great for large irrigation systems or areas with a lot of sediment in the water.



Super Disc Filter

Arkal designed the Super Filter for larger irrigation systems or for areas with a lot of organic matter (algae) in the water. The super disc set is twice the size of a standard Arkal disc set, giving a much larger filtering capacity and a higher flow. Arkal Super filters are rated up to 140 PSI.



Dual Lite Disc Filter

The 2" Arkal Dual Lite is substantially larger than any other screen or disc filter that we carry. The filtering area (147 sq. inches) is almost twice as large as the Arkal 1 1/2" filter. The plastic clasp easily opens to gain access to the discs inside. One major advantage of this filter is that the outlet can be on the side (standard), or it can be switched to the top of the filter





Sand Media Filter

Sand Media filters are designed to remove organic debris and particulates from water. Sand filters have a seamless fiberglass tank which won't corrode and are highly recommended for filtering water from ponds, creeks, or irrigation ditches.

The filter does not include the sand needed for operation.

Internal Operation Settings

- FILTER - From pump, through valve downward, through FILTER, up through center pipe to valve RETURN port for normal filter action
- BACKWASH - From pump through valve, down through center pipe and to valve WASTE port for cleaning filter by reversing flow
- RINSE - From pump, through valve downward, up through filter, up through center pipe to valve WASTE
- WASTE - From pump, through valve, bypassing FILTER, and to valve WASTE port
- CLOSED - NO FLOW - DO NOT USE THIS SETTING WITH PUMP OPERATING
- RECIRCULATE - From pump, through valve, bypassing FILTER and to RETURN port for circulating water without going through the FILTER

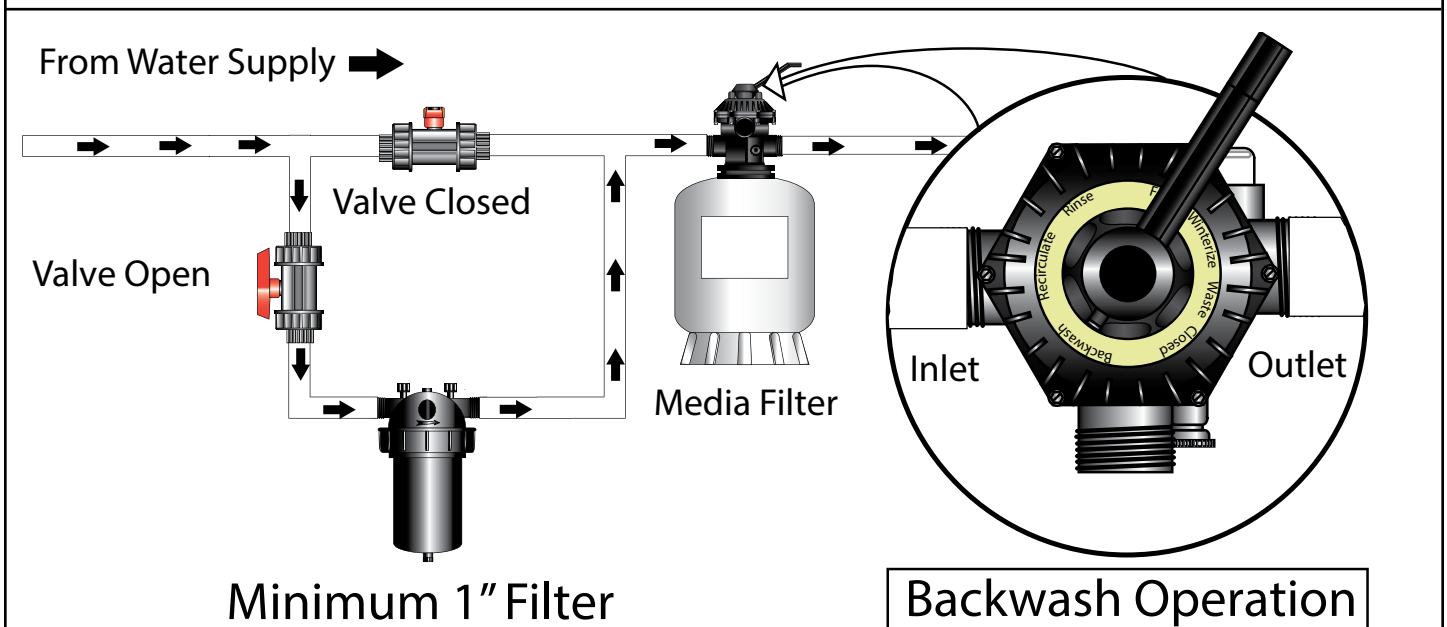
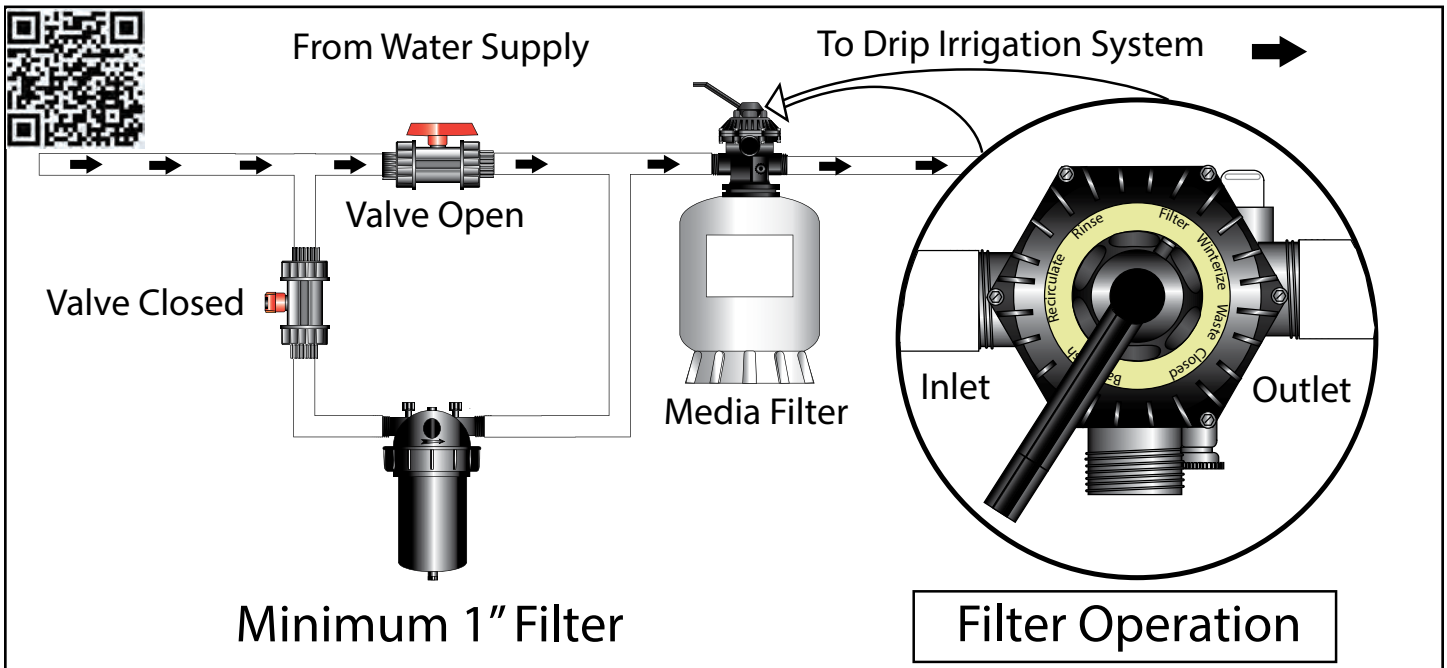

Gravity-Fed Drip Irrigation Systems

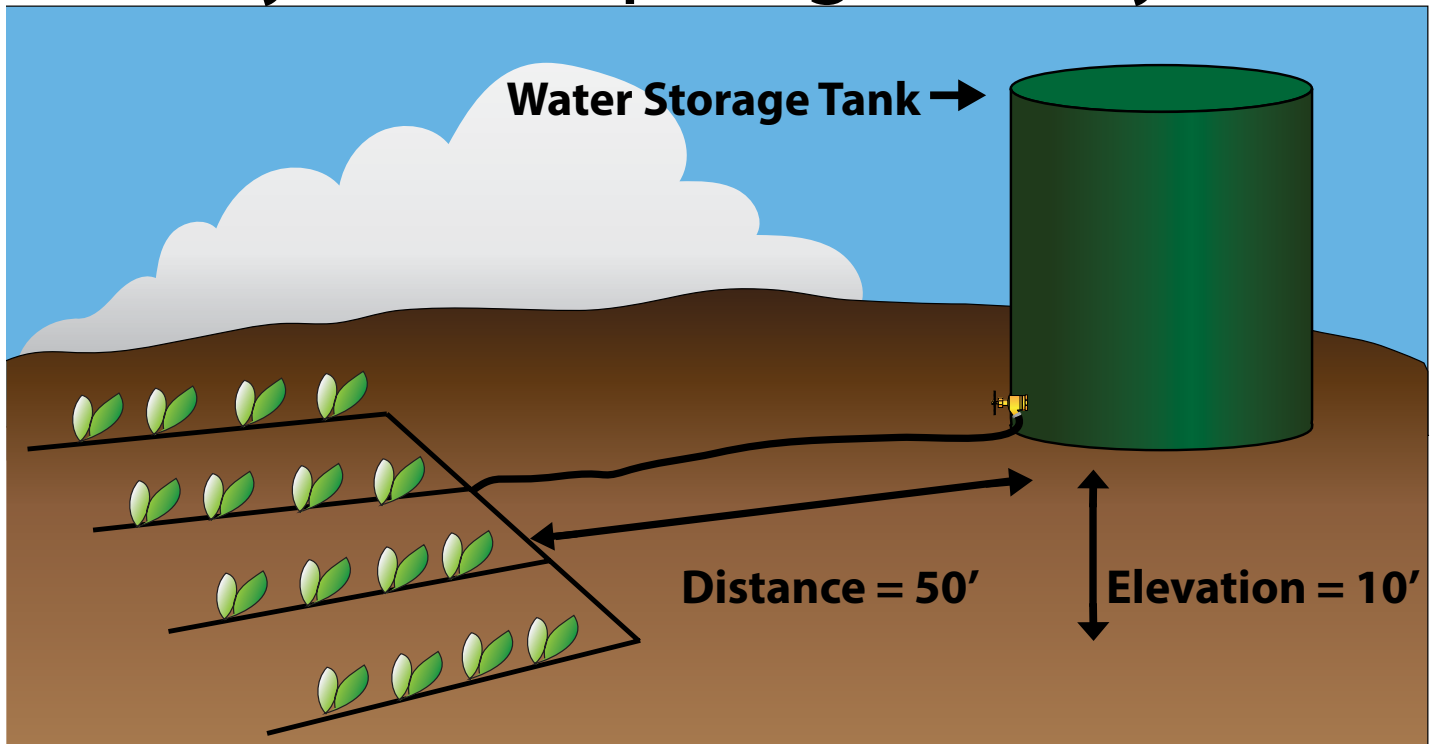

With gravity-fed systems, the volume of available water and flow rate take a back seat to pressure. All the water in the world is no good if you can't get it to flow evenly throughout your system and the only way to gain pressure in a gravity-fed system is by elevating your water source. For each 2.3' of elevation, approximately 1 PSI is gained, meaning the 10' of elevation in our example yields slightly over 4 PSI ($10/2.3 = 4.34$ PSI). Using a low pressure source to supply a drip irrigation system may require using products outside of the manufacturer's specifications. This means lower flow rates, smaller zones, and fewer emitters. For example: A 4 GPH emitter may output 1 GPH or less at lower pressures.

If you are not satisfied with your flow rate, you can increase the pressure of your system by:

1. Elevating the tank
2. Isolating into smaller sections (zones)
3. Adding a pump
4. Connecting to municipal water supply

Many are confused by the difference between distance and elevation, believing that the water's momentum will build pressure if there is significant distance between the garden and the water source. This is not true. In fact, there is more likely to be reduced pressure due to friction loss within the supply line.

However, having too much pressure is also a problem. If you're drawing from a source positioned on a ridge 200' above your garden area, the pressure will exceed the limits of your system before it ever reaches the first plant ($200/2.3 = 86.95$ PSI). In this case you'll need to use a regulator to step the pressure down, possibly more than once, to reach the 20-50 PSI range at the garden, a pressure level acceptable to a drip irrigation system.

Examples of gravity-fed drip designs are available in our free [Gallery of Plans](#).

Winterizing an Irrigation System

In most parts of the country there is concern about freeze damage to a drip irrigation system during winter. If this includes you, follow the simple steps below to ensure that your irrigation system is ready for winter.

Shut off and drain the system:

[Flush valves](#) can be installed at low points in the line to assist with draining the system. Flush valves will open every time the system shuts off, draining water trapped in the line. Emitters can also be installed at low points to assist with draining.



Blowing out the lines:

Another common method is to blow out the lines using compressed air. This is a time saving and effective method. Make sure to remove end fittings before blowing out the lines to avoid damaging the irrigation system.

Seal off the open lines:

After the lines have drained, make sure to replace all end fittings. Leave end caps loose to allow for draining throughout the winter. The beginning of the system where the faucet assembly was removed should be sealed off as well. Use a [hose thread plug](#) to seal the female hose start fitting at the beginning of the system. A plastic bag or other barrier could also be used to cover the opening of the system. Never leave lines open; debris, insects and other creatures may take shelter in the open lines.

Protect your plants:

To extend the growing season, [Rowcover](#) can be used to cover plants and protect them from frost damage.

Spring start-up:

When restarting the system for the new growing season, make sure to tighten all end caps and check for leaks or any damage that may have occurred over winter. New alkaline batteries should be installed in battery timers and any cracked or damaged system components replaced.

